

Torquetronic™ ET

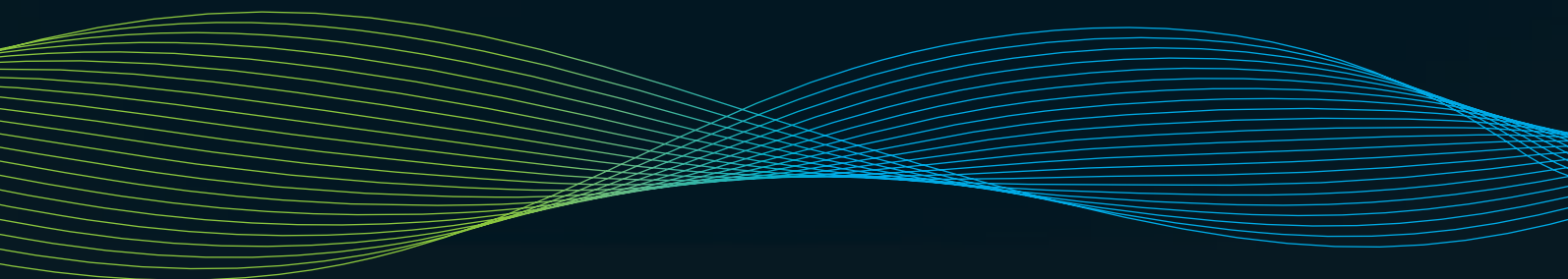

Torquemet
LIMITED

high performance test & measurement systems





Torquemeters Limited specialise in providing innovative products and custom engineered solutions for high performance rotating machinery applications with a reputation for excellent quality and service.



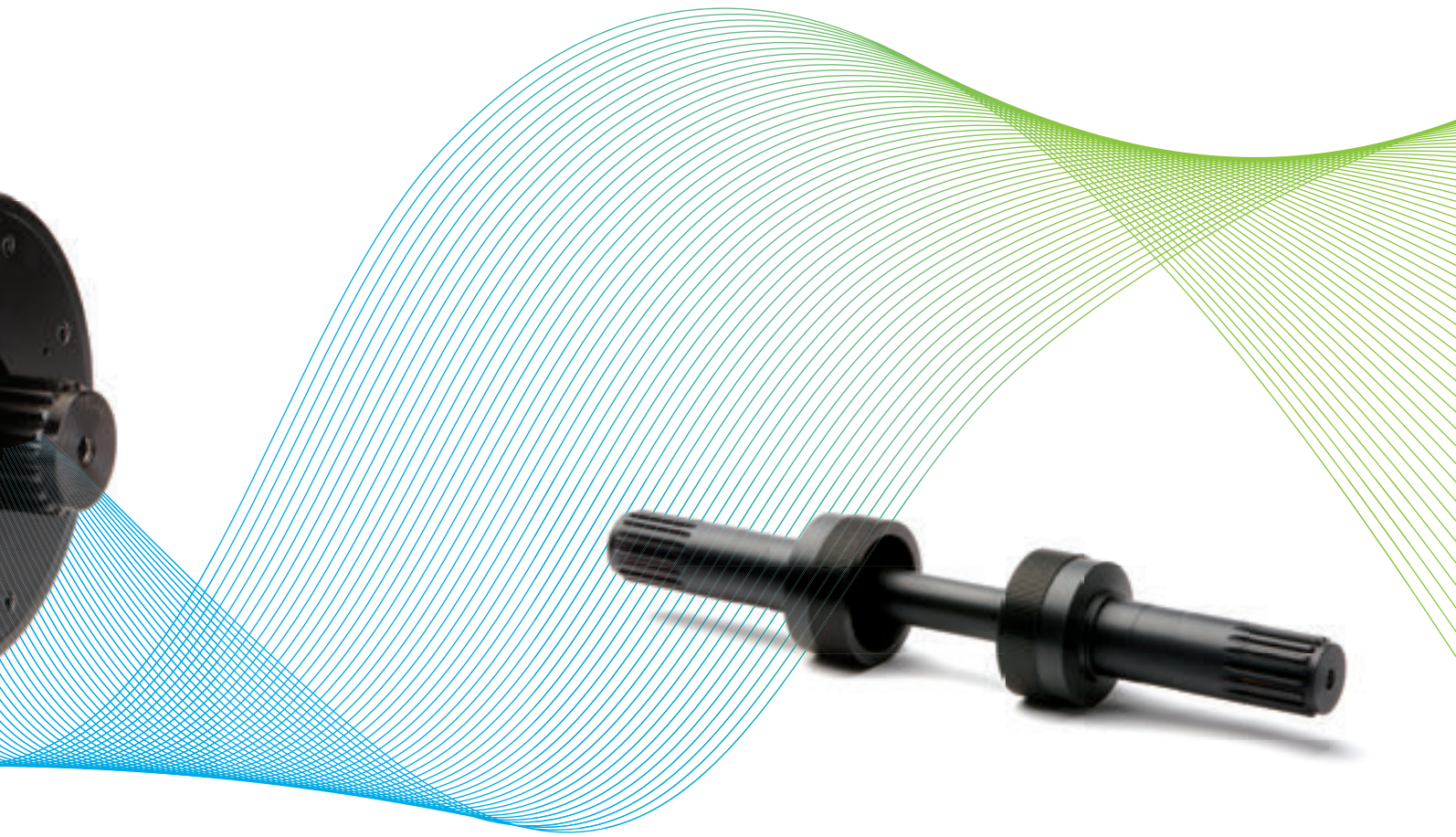

Transmission Applications

Aerospace:

Working with leading Aerospace manufacturers and systems integrators Torquemeters designs and manufactures high performance power transmission solutions for:

- Compressors & Turbines turbo shaft testing
- Helicopter transmissions testing
- Aero engine ancillaries: Alternators, Starters, Fuel pumps, Gears, Seals, bearings

Automotive:

- Turbocharger mapping
- Engine friction testing, Single Cylinder
- High performance engine recovery systems
 - FI KERS, MGU-H, MGU-K
- Driveline transmission component test

Industrial:

- Electric motor development
- Compressor & Turbine development
- Seal testing
- Power transmission component test

Torquetronic™ ET torquemeters use the phase shift principal with no shaft borne electronics, which gives almost unlimited speed capability, very high accuracy and credibility and a service life of over 30 years:

- Accuracy: 0.1% of Full Scale
- Speed rating to 150,000 rev/min
- Torque rating from 0.1 Nm to 77,000 Nm
- No rotating electronics
- Proven reliability & stability in demanding applications
- Interchangeable torsion shafts
- Custom designs available
- Integrated system solutions: Torquemeter and Couplings
- Intrinsically Safe also available

**More than a product..
a complete driveline solution.**

The testing of modern helicopter turbo shaft engines occurs across a wide spectrum, from initial and on-going engine development, to production pass off by the OEM through Maintenance, Repair and Overhaul (MRO) by both military and civil operators.

Torquemeters Ltd has become established as the preferred supplier for the world's most popular turbo shaft engines:

GE's - T700/701K, T55,56, T64, GE38

P&W - PT6, PW210 families

Turbomeca's - Arriel, Makila and RTM322 engines.



1. Flange mount torquemeters, designed to directly mount from gearbox.
2. Custom design torque measurement solution for US Navy and Army for turbo shaft engine testing on the Varoc™ air dyno.
3. Typical test bed installation for turbo shaft engine: Pedestal ET3075 torquemeter and couplings; 750HP, 24,000 rpm.
4. Example of Turbo shaft engine test coupling.
5. Typical arrangement Torquetronic™ ET2145, Tordics couplings to a bookend mount for the test article. 1,400Nm, 32,000 rev/min
6. 120,000 rpm driveline to test article book end.
7. Pedestal Torquemeter – can also act as a bearing pedestal between driving and driven machine.

1.

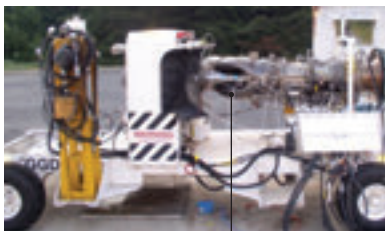

2.



3.

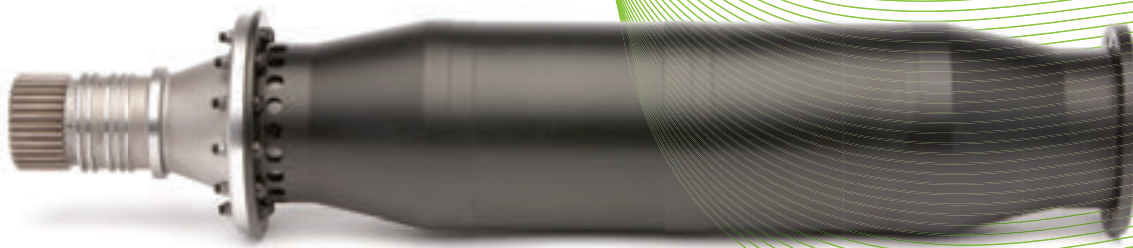

4.



5.

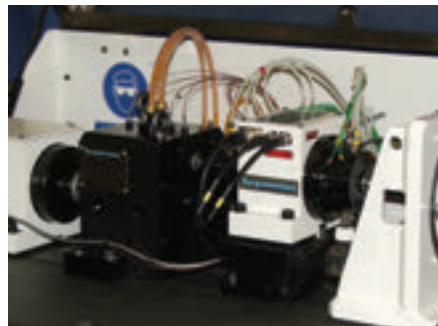

6.



7.

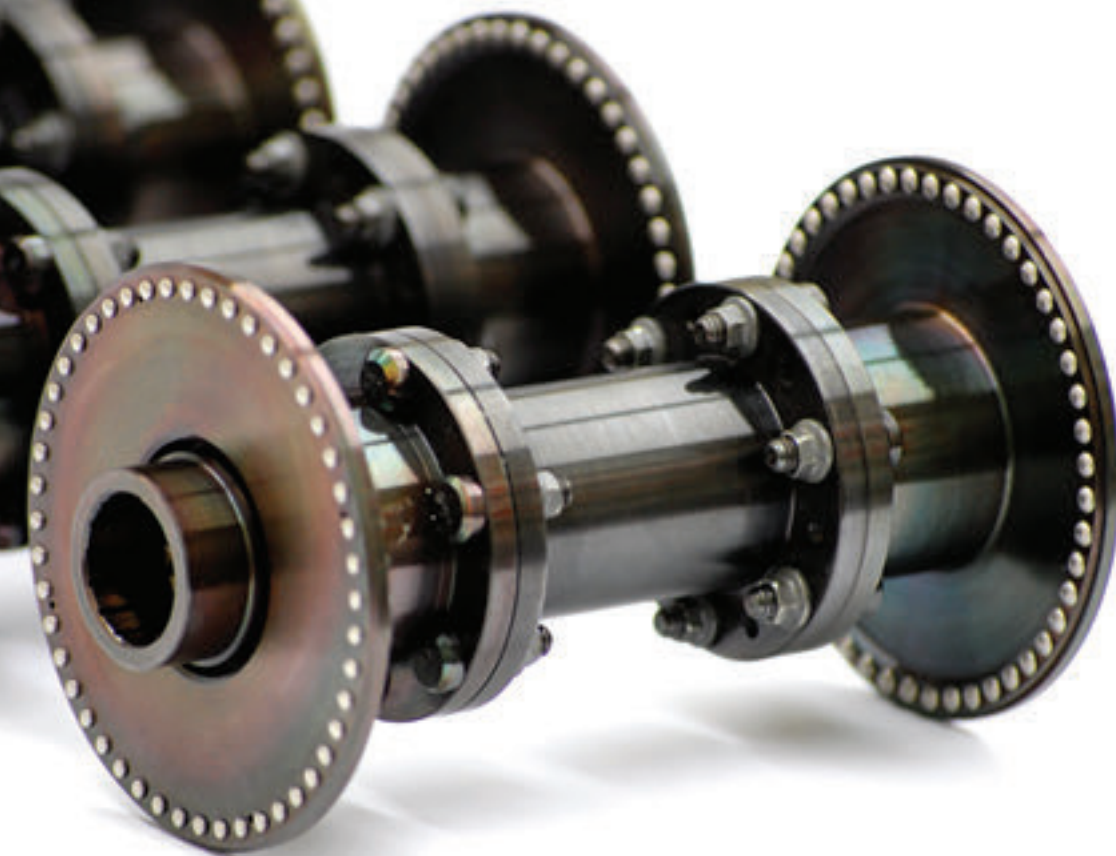

**130,000 rpm ± 20Nm
Driveline solution**

Because of Mass Overhang constraints affecting critical speed, spindles were introduced in the transmission driveline.

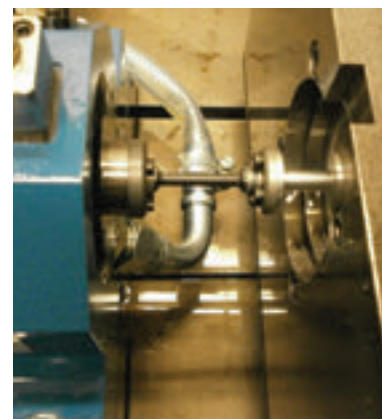

TORDISC™ Model	Cross reference to ET Model	SHAFT Ø (mm)	SPEED (rpm)	Nominal	
				TORQUE (Nm)	SPACER LENGTH (mm)
LM110	ET1103/1105	17	70000	100	50
LM118	ET1183/1185	20	60000	180	70
LM130	ET1303/1304	25	44000	300	70
LM206		30	41000	600	150
LM209	ET2095	35	38,000	900	150
LM214	ET2143/2145	40	32,000	1,400	200
LM230	ET2303/2305	50	26000	3,000	200
LM304	ET3045	55	23000	4,000	200
LM305		60	22000	5,400	200
LM307	ET3073/3075	65	21,000	7,000	200
LM309		70	20,000	8,500	200
LM311	ET3115	75	18000	11,000	200
LM317		85	15000	17,000	200
LM320	ET3205	90	14000	20,000	
LM405	ET4055	120	11000	47,000	
LM408	ET4085	140	9000	77,000	

Transmission Drivelines

Though the ET torquemeter is designed to be insensitive to external shaft loading the transmission driveline is critical to a successful installation and operation.

We have extensive experience in transmission engineering available to assess and recommend coupling selection:

- Disc pack
- Tordisc™ Diaphragm
- Quill

A range of factors must be considered for the transmission driveline, especially for high performance applications:

The Speed, Torque envelope, Axial Deflection and Angular Deflection while respecting the acceptable overhung mass limitations of the various components in the transmission driveline.

Torquemeters Ltd can provide full design support which includes FEA analysis.

Typically for applications over 80,000 rpm we recommend a Quill or Gear coupling, it provides torsional flexibility.

Example of Quill design.



Centrifugal growth

- Coupling hub fits
- Bearing fits (non-catalogue)
- Bearing internal clearances

Rotordynamics

- Shaft rock and bounce modes (bearing dynamic radial stiffness)
- Shaft bending critical modes
- Shaft running envelopes (sub or super critical)

Tordisc™

- Light weight diaphragm coupling
- Reduced overhung mass and inertia
- **Shear Neck** can be included in the spacer shaft, acting as a mechanical fuse to limit damage in case of test article failure

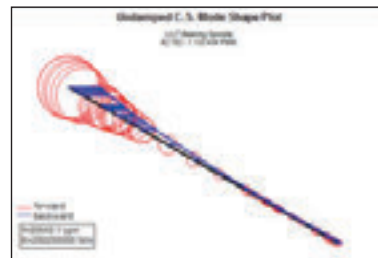
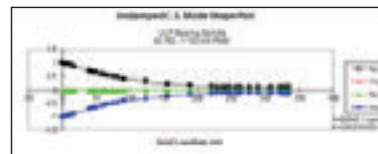

MISALIGNMENT - nominal spacer length

Axial mm	Parallel mm	Mass O/H kg	Inertia kg.m ²	ASSEMBLY DRG. No.	Removal & Assembly Tooling No.
±0.58	0.4	0.23	0.000141	05-1105-00	
±1.0	0.5	0.329	0.000274	05-1185-00	
±1.1	0.4	0.4	0.000407	05-1305-00	
±0.9	0.8	0.695	0.00085	05-2065-00	
±1.15	0.8	1.02	0.00188	05-2095-00	
±1.8	1.0	1.56	0.00376	05-2145-00	06-2145-03
±1.8	1.0			05-2305-00	
±1.8	1.0			05-3045-00	
±2.64	1.25	6.5	0.04	05-3055-00	
±3.0	1.26	7.28	0.064	05-3075-00	
±3.0	1.26	9.28	0.108	05-3095-00	
±4.0	1.26			05-3115-00	
±4.0	1.27	14.47	0.208	05-3175-00	
				05-3205-00	
				05-4055-00	

ET Selection Chart

Series 0 - Purple Series 1 - Grey Series 2 - Orange Series 3 - Blue Series 4 - Green

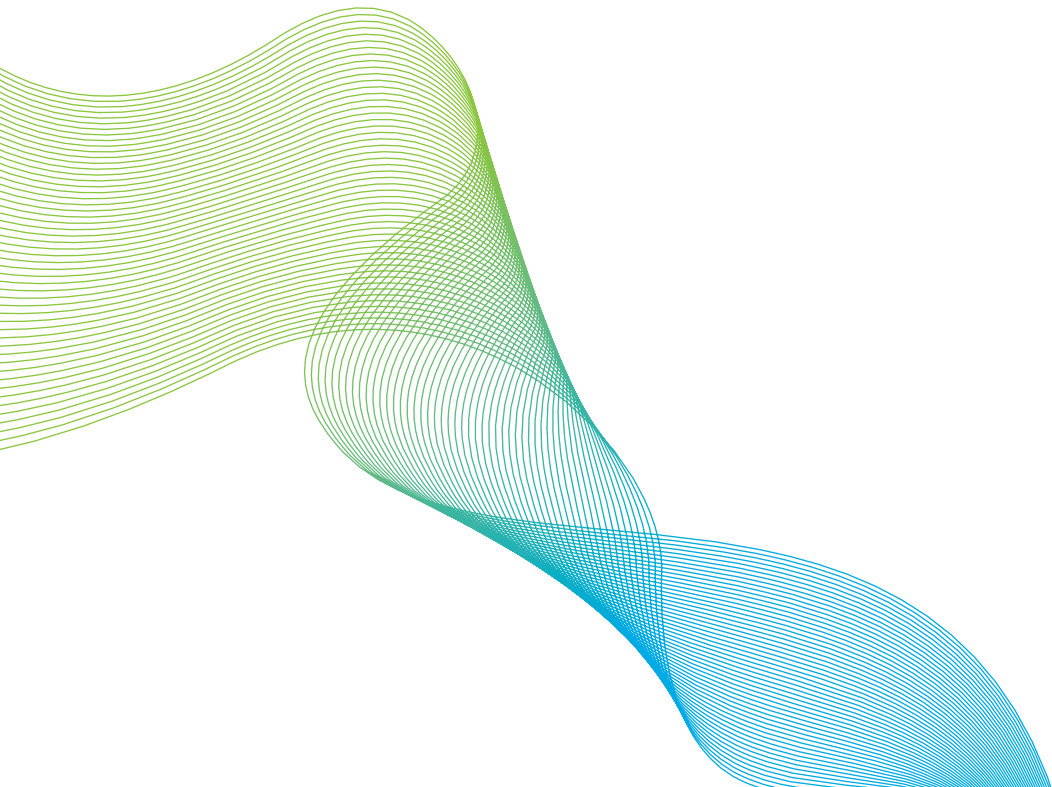
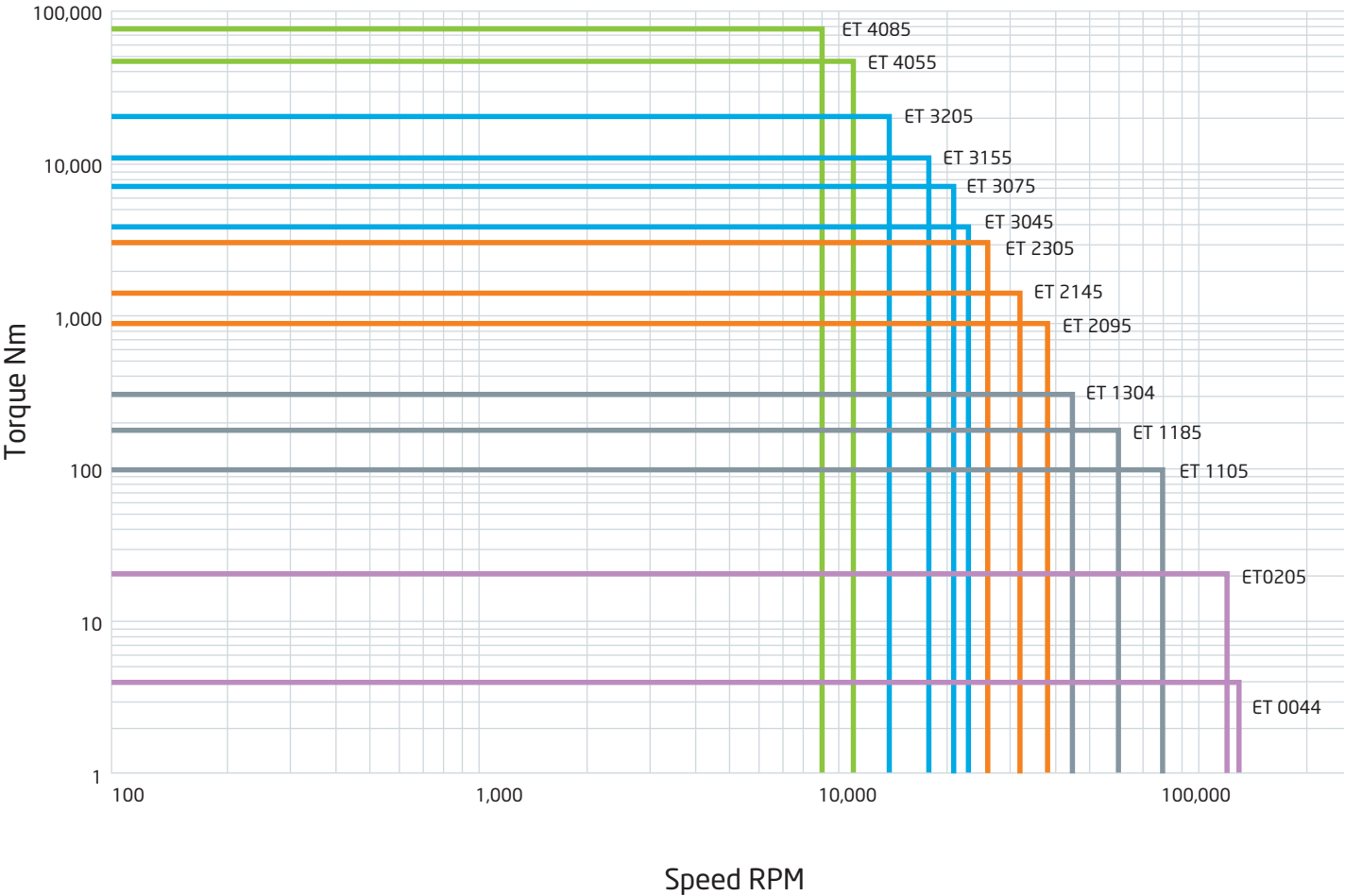

ET Model List

ET MODEL	TYPE	MAX	MAX	Bearing		Lubrication	Cartridge
		Nmw	Rev/Min	Bore	Qty	Type	Y/N
0044	High Speed	4	120,000	8	4	Oil	Y
0043	Medium Speed	4	90,000	8	4	Grease	Y
0103	Medium Speed	10	90,000	8	4	Grease	Y
0205	High Speed	20	120,000	10	4	Oil	Y†
1050	Low Speed	50	20,000	20	2	Grease	Y†
1057	Suspended	50	10,000	20	2	Grease	Y†
1100	Low Speed	100	16,000	25	2	Grease	N
1107	Suspended	100	10,000	25	2	Grease	N
1300	Low Speed	300	12,000	35	2	Grease	N
1307	Suspended	300	10,000	35	2	Grease	N
1103	Medium Speed	100	52,000	17	4	Grease	Y
1105	High Speed	100	80,000	17	4	Oil	Y
1183	Medium Speed	180	42,000	20	4	Grease	Y
1185	High Speed	180	60,000	20	4	Oil	Y
1303	Medium Speed	300	36,000	25	4	Grease	N
1304	High Speed	300	44,000	25	4	Oil	N
2051	Low Speed	560	12,000	40	2	Grease	Y†
2058	Suspended	560	6,000	40	2	Grease	Y†
2070	Low Speed	700	12,000	40	2	Grease	Y†
2077	Suspended	700	6,000	40	2	Grease	Y†
2350	Low Speed	3,500	8,000	55	2	Grease	N
2357	Suspended	3,500	6,000	55	2	Grease	N
2700	Low Speed	7,000	5,500	70	2	Grease	N
2707	Suspended	7,000	5,500	70	2	Grease	N
2095	High Speed	900	38,000	35	4	Oil	Y
2143	Medium Speed	1,400	22,000	40	4	Grease	Y
2145	High Speed	1,400	32,000	40	4	Oil	Y
2303	Medium Speed	3,000	18,000	50	4	Grease	N
2305	High Speed	3,000	26,000	50	4	Oil	N
3200	Low Speed	20,000	4,500	100	2	Grease	N
3045	High Speed	4,000	23,000	55	4	Oil	Y
3073	Medium Speed	7,000	14,000	65	4	Grease	Y
3075	High Speed	7,000	21,000	65	4	Oil	Y
3115	High Speed	11,000	18,000	75	4	Oil	N
3205	High Speed	20,000	14,000	90	4	Oil	N
4050	Low Speed	47,000	3,000	120	2	Grease	N
4055	High Speed	47,000	11,000	120	2	Oil	N
4085	High Speed	77,000	9,000	140	2	Oil	N

PRODUCT DATA SHEET

ET2145 High Speed Torquemeter

Model Rating

Maximum Continuous Torque: 1400Nm
 Maximum Continuous Speed: 32000rpm

Shaft Rating Range 140Nm to 1400Nm
 Accuracy at Full Scale Torque 0.12% Application Dependant



Specification

Number of Bearings	4
Bearing Temp. Quantity	1 Per Bearing
Bearing Temp. Monitoring	See GDS01
Bearing Lubrication Type	Oil
Fluid Port Type	See GDS01
Accelerometer Mounting	2-off Each End. See GDS01
Rotastat Voltage	See GDS

Environment

Storage Temperature	-50 to 85°C
Operating Temperature	-20 to 80°C

Outline Drawing

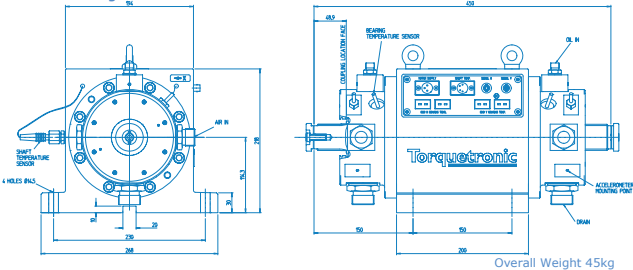

Overall Weight 45kg

For more detail see drawings

INST02-2145-00	For installation drawing
02-2145-00	For itemized assembly drawing
E850001	For typical electrical connection drawing
03-2145-00	For drawing of optional calibration tooling
06-2145-00 & 06-2145-01	For optional bearing removal and refitting tooling



Torquemeters Limited
 Ravensthorpe, Northampton, NN6 8ET, United Kingdom.
 Telephone: +44 (0)1604 770232 Fax: +44 (0)1604 770778
 email: info@torquemeters.com www.torquemeters.com



A technical specification is available for each of our standard ET torquemeters. This provides installation and driveline details that must be considered for successful operation.

Model Rating

Defines maximum rating for the specific model. You can select any Full Scale rating of your torsion shaft down to 10 % of model rating. This ensures optimum accuracy of measurement.

For example the ET2145 has a model rating: 1,400 Nm 32,000 rpm

If your application has maximum Full Scale of 525Nm. The Torsion shaft should be specified at 525Nm, therefore measurement accuracy of 0.1% will be of 525Nm rather than 1,400Nm.

Inter changeable Torsion shafts

Torsion shafts of different ratings can be used in the same ET model, this is a unique feature that means a single model can be used for testing a wide range of application torques at optimum Full Scale accuracy.

Coupling Specification

Recommended Coupling	TORDISC LM214
Shaft End Type	Splined DIN 5480 - 40 x 2 x 18 x 7H 8f
Shaft Diameter Nominal	40mm

Bearing Lubrication Requirements

Lubrication Type	Oil Jet
Oil type	ISO VG32
Oil inlet temperature	35 ± 5 °C
Oil supply pressure	200 ± 50 kPa
Oil quantity	135 l/hr @ 200 kPa
Oil filtration	10 µm

Seal Air Supply Requirements

Air pressure	4 ± 1 kPa
Air quantity	75 m³/hr

Cartridge Style

Interchangeable torsion shafts for ET2145 supplied with bearings as a cartridge assembly

Permissible Speed vs Coupling C of G Overhang

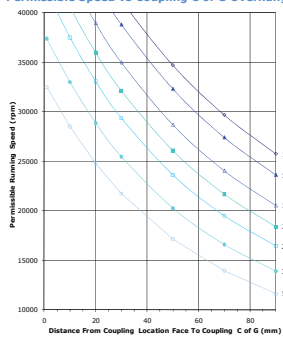

Inertia and Torsional Stiffness vs Shaft Rating

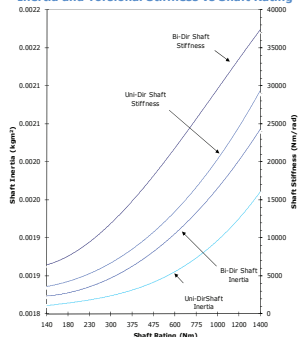

Please refer to Technical Data Sheet (TDS01) for details of Torquetronic Torquemeter phase shift system.
 Please refer to Generic Data Sheet (GDS01) for details of Torquemeter options.

Permissible Speed vs Coupling C of G overhang

The acceptable half mass of couplings related to the C Of G from the coupling location face (see outline drawing of model) are shown graphically for each model. These parameters should be observed to prevent issues of critical speed and reduced bearing life.

Inertia and Torsional stiffness vs Shaft Rating Details are provided for rotor dynamic analysis.

$$\text{TORQUE} = \text{SHAFT STIFFNESS} \times (\text{PD-ZERO TORQUEDATUM})$$

100

All ET Torquetronic™ torquemeters are calibrated at our factory both statically and dynamically and supplied with full calibration certificates.

STATIC calibration:

Shaft Stiffness is determined from the torque required to twist the torsion shaft through one signal tooth pitch i.e. 100% PD. The value of stiffness is found by performing a static calibration on the transducer using lever arms and weights. The calibration is stable as Youngs Modulus and is strictly linear.

Dynamic Calibration:

Zero Torque Datum (ZTD) is the Phase Displacement produced when the torquemeter is rotating through its entire speed range, but not transmitting torque. Torquemeters are dynamically calibrated in the factory to establish the as built ZTD, however to maximise accuracy it is generally essential to carry out another dynamic calibration on installation to establish the in situ ZTD and would compensate for any additional losses. For example: a bearing pedestal between the torquemeter and the test article.

- Resolution
- Linearity + Hysteresis
- Zero repeatability
- Temperature Compensation
- Static Calibration
- Speed

Overall accuracy '95% confidence level

Absolute: ± 0.12% FS

Repeatability: ± 0.1% FS

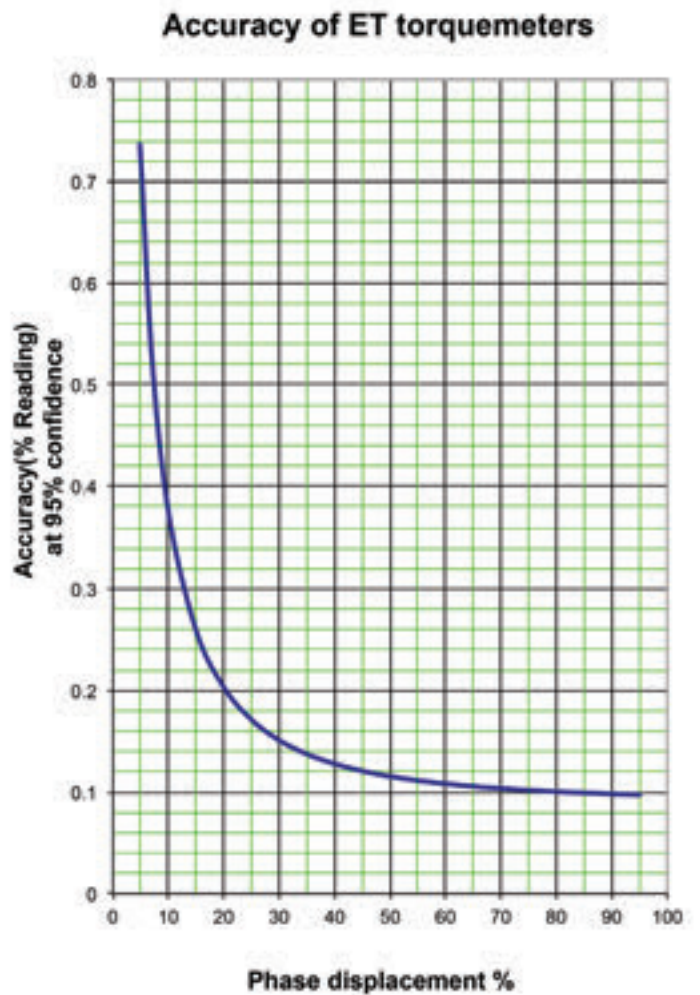

HIGH PERFORMANCE ET TORQUETRONIC™ TORQUEMETER.

The ET Torquemeter measures torque using the principal of phase shift which negates the complexities and limitations associated with rotating electronics and amplifiers that are subject to zero shift and gain changes with temperature.

Phase Shift

The ET models are specifically designed for high performance and demanding duty applications.

- Ultra high speed
- Extremely high measurement stability
- Active Temperature Compensation
- Statically and dynamically calibrated
- Interchangeable Torsion Shafts
- On Site Calibration
- 200% Overload Capacity

Phase Shift Principal

A phase shift torquemeter measures torque by directly measuring the twist in the torsion shaft. The 'Torquetronic™' system has multipole pickups in the form of fixed toothed rings with an embedded coil surrounding the torsion shaft flange teeth.

The coil is energised to provide a toroidal flux path, as the shaft rotates the torsion shaft flange teeth pass through the flux path to generate a sinusoidal voltage in each coil. The phase relationship between the two wave forms is then used to measure the torque. As torque is applied to the rotating shaft, a change of phase occurs between the two signals.

The benefit of a multipole pickup is that the phase output is completely immune to errors due to bending of the shaft as radial movements of the shaft cause an early signal at one tooth it is compensated by a late signal from the opposite tooth.

ET torquemeters are provided in five frame sizes; 0,1,2,3,4 to cover a range of applications with some models available in either suspended or pedestal formats. (Please refer to selection chart on page 5)

All ET Torquemeters have a maximum model rating but are supplied with torsion shafts designed for the specific Full Scale rating of the application. This ensures optimum accuracy and resolution of the article under test.

The **“Interchangeable Torsion Shaft”** capability provided by the ET range is a unique feature that allows a single instrument to be used for the testing and evaluation of a wide range of torques at maximum accuracy in a cost effective manner.

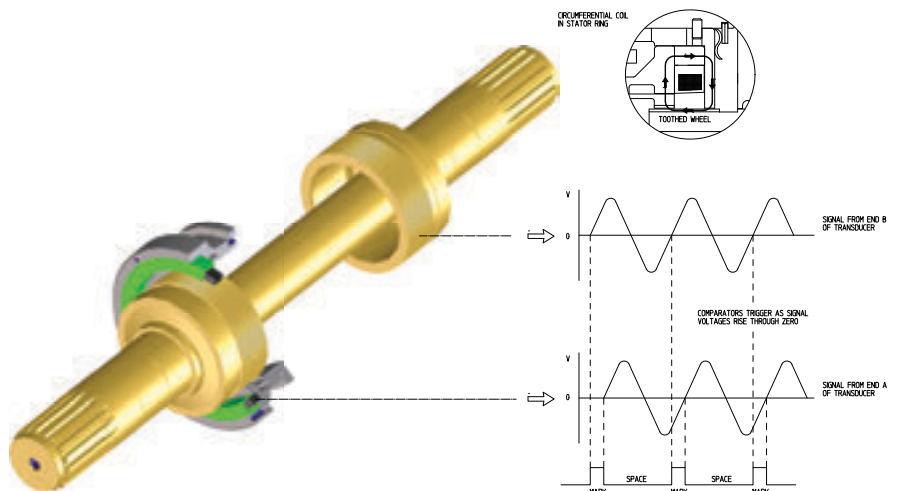

1. Torsion shaft

ET Torquemeters will operate in 4 quadrant modes measuring speed (Direction of Rotation) and torque (Helix) in both directions. However for optimum accuracy a Uni Directional shaft can be selected. Shaft ends as standard have DIN 5480 splines, please refer to data sheet for specific detail.

2. Cartridge Style

As part of the "Interchangeable Torsion Shaft" system, the cartridge assembly includes the torsion shaft, the bearing sleeve and bearings. A non cartridge style torquemeter will require the bearing housings and possible other components to be dismantled in order for the torsion shaft to be changed.

3. Bearings

ET torquemeters models have either 2 bearings or 4 bearings. High Speed ET's have angular contact type bearings that are oil jet lubricated. Oil leakage from the bearing housings is prevented by using air-blown seals. Medium Speed ET's have angular contact type bearings that are grease lubricated. Low Speed ET's have deep groove type bearings that are grease lubricated.

4. Rotastat

'Torquetronic™' pedestal models feature a built in Rotastat™ system in which the pickup teeth can be rotated to generate signals with the shaft stationary. This feature is essential for the static calibration, but it also allows torque to be measured at very low speed or stationary. The rotastat motors are supplied as 12VDC or 24VDC as standard.

5. Bearing Temperature Monitoring

PT100 TRD monitor the temperature of each bearing independently.

6. Vibration Monitoring

There are accelerometer mounting features located at 90° from each other at both ends of the torquemeter for vibration monitoring. Note: Due to the size of the torquemeter some models have one mounting feature at each end of the torquemeter, refer to product data sheets. The accelerometer mounting features are available in the following thread sizes: M4, M5, M8, and 5/16"UNF.

7. Fluid Fittings - High speed models only

7 Fittings for the bearing lubrication supply (a), seal air (b) and oil/air drain (c). Please refer to data sheet for specific utility supply requirements – Air, Oil flow and pressure requirements.

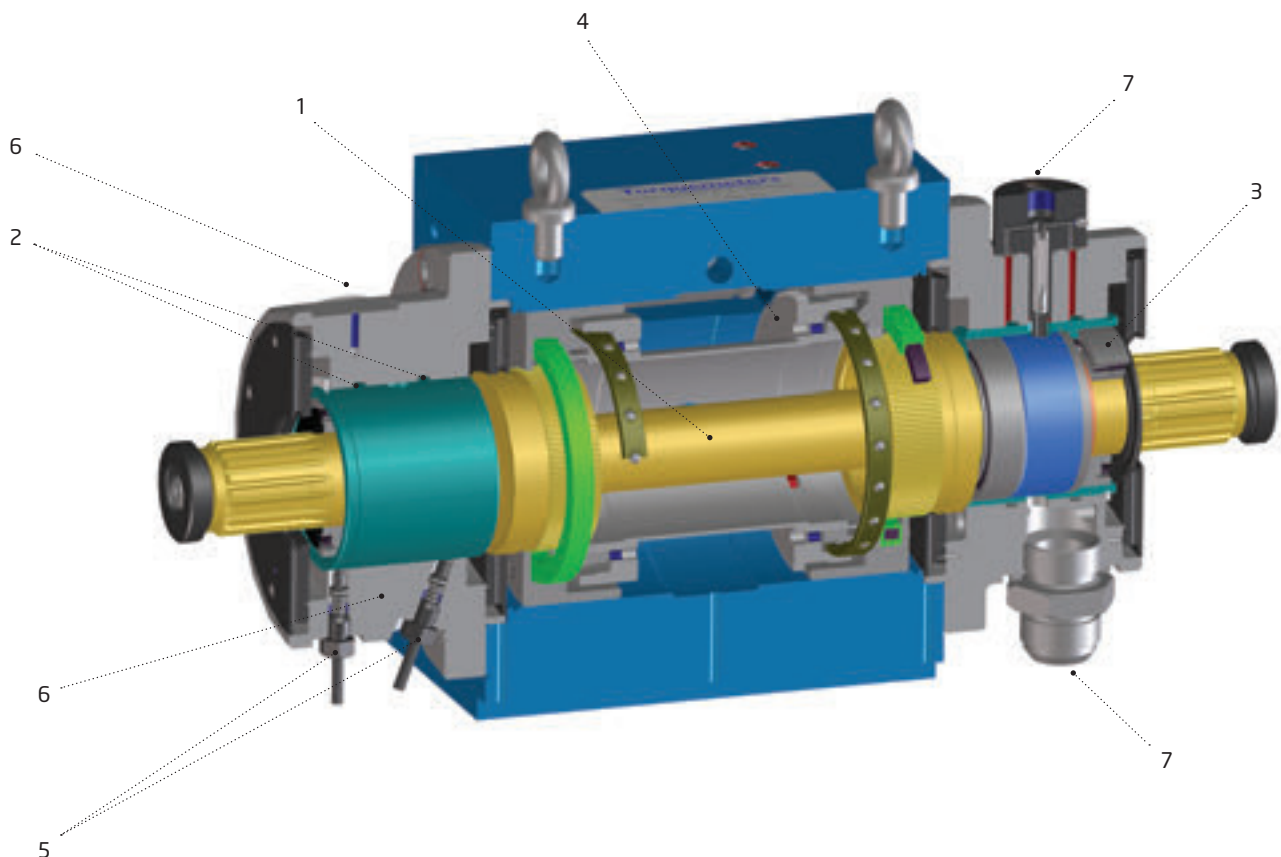

The basic relation used to find torque from Phase Displacement (PD) is:

NEW GENERATION DELIVERING INCREASED PERFORMANCE.

THE 800 FAMILY OF PRODUCTS OFFERS A FLEXIBLE DISPLAY AND DATA ACQUISITION PLATFORM FOR ALL TORQUETRONIC™ TORQUE MEASUREMENT SYSTEMS.

Measuring steady state torque and **Torsional Vibration** in a single product.

The high measurement resolution of the Torquetronic™ system means it automatically captures torsional vibration present in the driveline.

TorqTo™ process the data, sampled at up to 10KHz, and provides detailed analysis.

TorqTo™ performs a Fast Fourier Transform (FFT), and displays torsional frequencies against amplitude. Analysis can be displayed in a Campbell Diagram / Colour map of torsional frequencies or Modal Plot orders against machine speed.

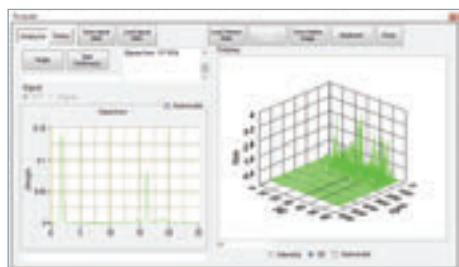

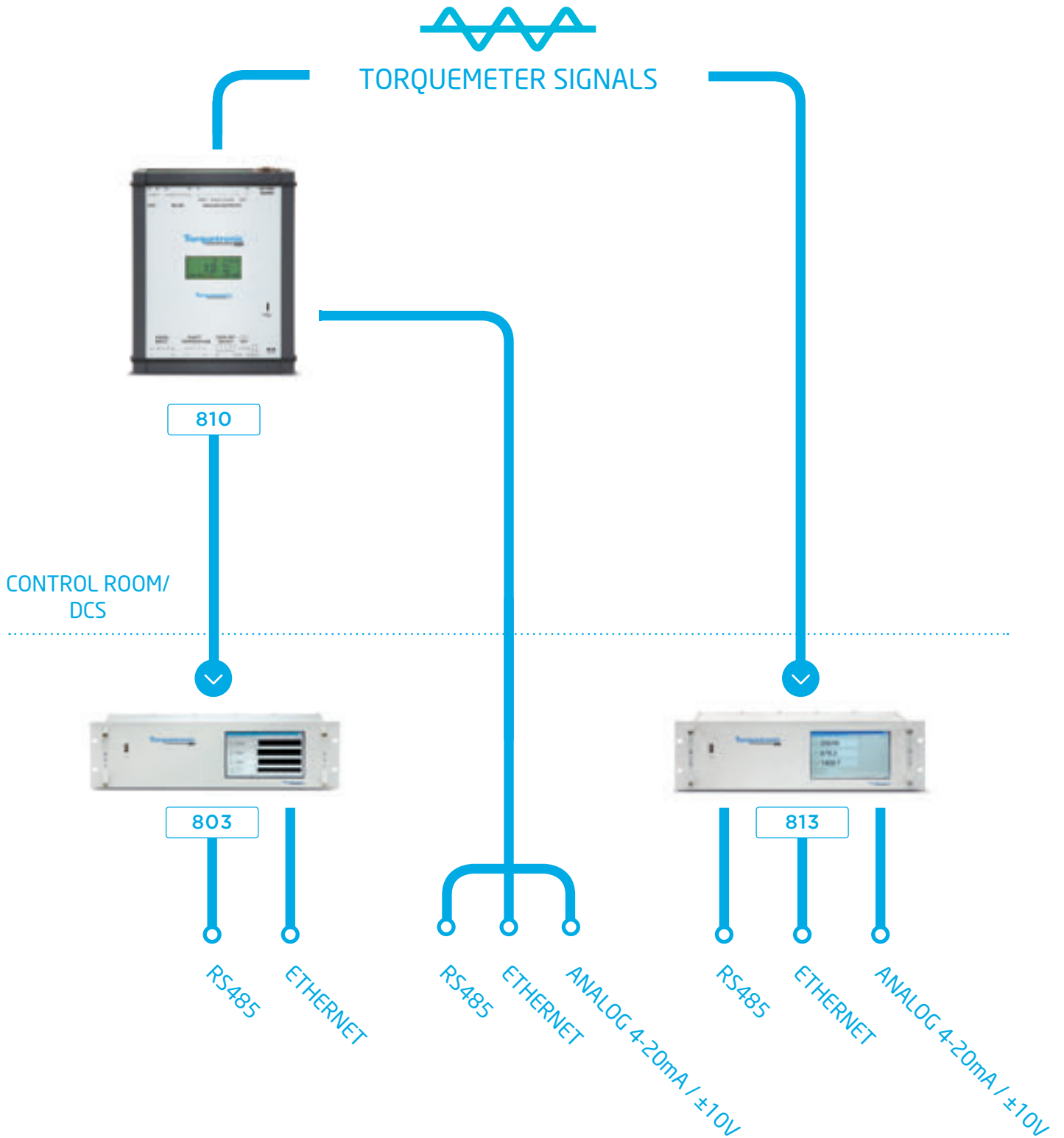

TYPICAL SYSTEM CONFIGURATION



Torqueters Limited
West Haddon Road
Ravensthorpe
Northampton NN6 8ET
United Kingdom

Tel: +44 (0) 1604 770232
Fax: +44 (0) 1604 770778
sales@torqueters.com

www.torqueters.com