

## ELAF LOAD CELL

### SPECIFICATIONS

- ◆ **Compact Design: 12.7mm [0.5"], 15.88mm [0.625"] and 31.75mm [1.25"] Diameter**
- ◆ **Compression/Tension**
- ◆ **Stainless Steel Body**
- ◆ **50 – 10KN [10 – 2000lbf]**
- ◆ **Amplified or mV Output**
- ◆ **Temperature Compensated**
- ◆ **High Stability**
- ◆ **Industry Standard Packaging**
- ◆ **Resists Off Axis Load Components**
- ◆ **Full NIST Traceable 11 Point Calibration**
- ◆ **Shielded FEP/PTFE Cabling with Strain Relief**
- ◆ **Variety of Options Available**
- ◆ **IP65 Weatherproof**

The ELAF series compression and tension load cells raise the bar for high performance at low cost. Measurement Specialties proprietary Microfused® technology, derived from demanding aerospace applications, employs micro-machined piezoresistive strain gages fused with high temperature glass to a high performance stainless steel force measuring flexure. Microfused® technology eliminates age-sensitive organic epoxies used in traditional load cell designs providing excellent long term span and zero stability. Operating at very low strains, Microfused® technology utilizes strain gages providing gage factors greater than 100, an essentially unlimited cycle life expectancy, superior resolution, exceedingly high over-range capabilities (without the need for stops) and an amplified ratiometric high level 0.5 to 4.5 V output or 20 mV/V bridge output. Microfused® sensors are ideal for your test and measurement applications. From the ultra compact 0.5" diameter B0 and T1 design to the high range 1.25" diameter B2 package, the ELAF provides exceptional flexibility and superior performance.



### FEATURES

- ◆ **Low Cost**
- ◆ **Optional High Level Output**
- ◆ **Small, Low Profile Design**
- ◆ **Low Noise**
- ◆ **Robust: High Over Range**
- ◆ **High Reliability**
- ◆ **Low Deflection**
- ◆ **Low Off-Axis Response**

### APPLICATIONS

- ◆ **Theatrical Rigging Loads**
- ◆ **Assembly Forces**
- ◆ **Weighing**
- ◆ **Tool Forces**
- ◆ **Thrust Measurements**
- ◆ **Batch Weighing**
- ◆ **Robotics End Effectors**
- ◆ **Product Validation Testing**
- ◆ **Material Test**
- ◆ **Hoist and Winch Loads**

## ELAF LOAD CELL

Measurement Specialties' ELAF Test and Measurement series sensors, unlike most designs, are provided with a "four-bar" design where a flexible diaphragm parallels the measuring flexure. This configuration is far less susceptible to off-axis load components than single diaphragm traditional designs. Shielded, FEP/PTFE insulated instrumentation cabling is provided along with spring steel strain reliefs and full NIST traceable calibration certificates. The ELAF unit is fully thermally compensated and can be configured with a variety of options to fine tune the instrument to your application: select from several standard package geometries. Compensated temperature ranges, input voltages, lead lengths or specify entirely unique combinations of these options.

### STANDARD RANGES

Lbf	N	Body Style
10L	50N	B0, T1
25L	125N	B0, T1
50L	250N	B0, T1
100L	500N	B0, T1
250L	1250N	B0, T2
500L	2500N	B0, T2
1000L	5KN	B1,
2000L	10KN	B2

### PERFORMANCE SPECIFICATIONS

**Supply Voltage: 5V**

**Ambient Temperature: 25°C (unless otherwise specified)**

PARAMETERS	MIN	TYP	MAX	UNITS	NOTES
Recommended Excitation (mV Output)		5		V	
Recommended Excitation (Amplified)	4.75	5	5.25	V	
Zero Output (mV Output)		0mV ± 5% FSO			
Zero Output (Amplified)		0.5V ± 3% FSO			
Output Span (mV Output)		20mV/V ± 5% FSO			5V Supply
		20mV/V ± 5% FSO			2.5V Supply
		10mV/V ± 5% FSO			10V Supply
Output Span (Amplified)		4V ± 3% FSO			Ratiometric to Supply Voltage
Non-Linearity	-0.25		0.25	%FSO	
Hysteresis	-0.25		0.25	%FSO	
Thermal Zero Shift	-0.03		0.03	%FSO/ °C	Reference to 25°C
Thermal Sensitivity Shift	-0.03		0.03	%FSO / °C	Reference to 25°C
Maximum Over Load		250		%FSO	
Humidity	0		95	%RH	Non-Condensing
Deflection			0.05	MM	At Rated Load
Impedance In (mV Output)	2.5	3.0	3.5	KΩ	
Impedance Out (mV Output)	1.7	2.2	2.7	KΩ	
Operating Temperature	-40		+120	°C	
Compensated Temperature	20		80	°C	Other Options Available
Insulation Resistance (250Vdc)	50			MΩ	
Weatherproof		IP65			

#### Additional Notes

1. Cable: FEP/PTFE Shielded 34# AWG.
2. Body: Stainless Steel

**ELAF LOAD CELL**

**DIMENSIONS IN MM (INCH)**

COMPRESSION FORCE

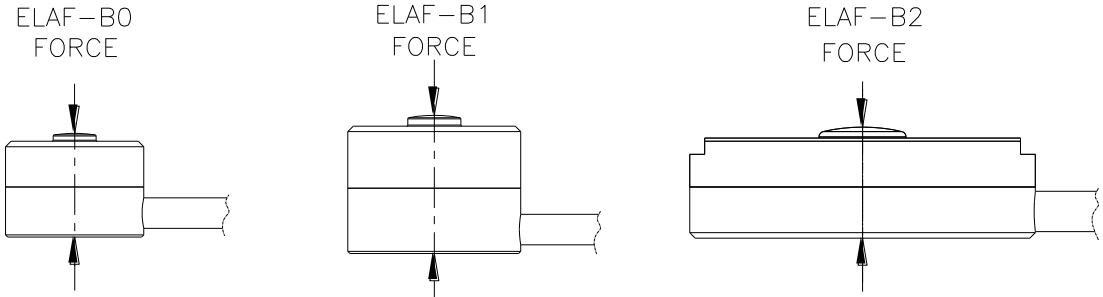
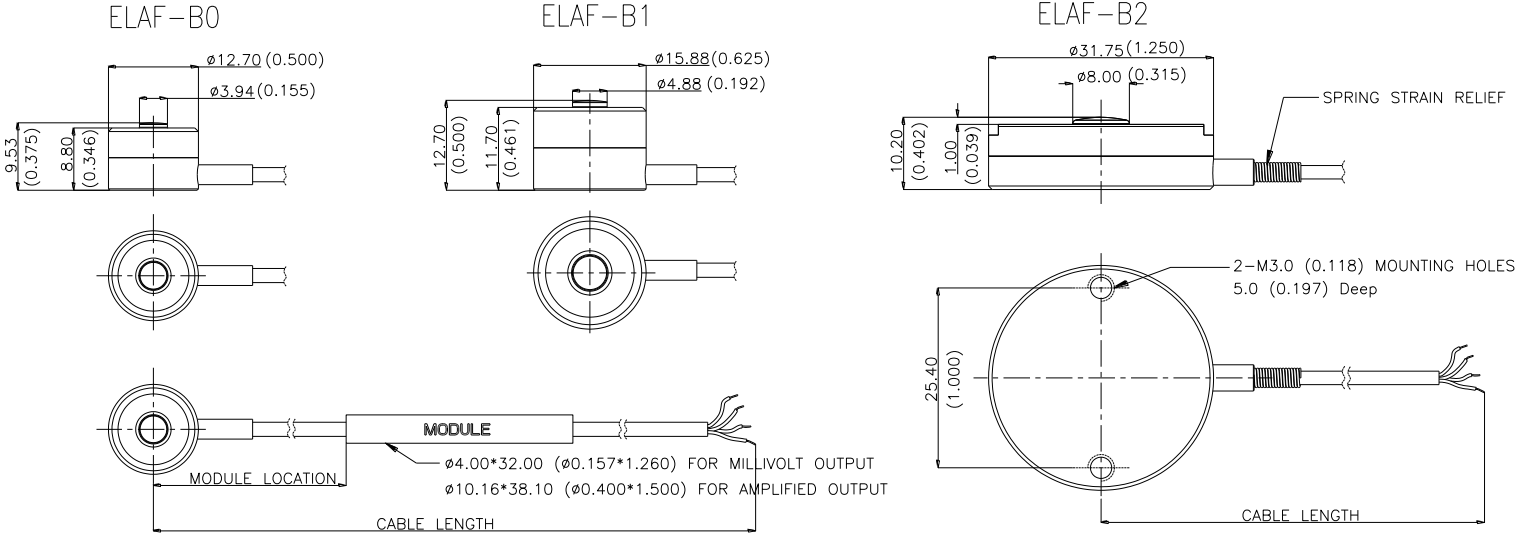

BO, B1 & B2: SPHERICAL CONTACT ON THE TOP AND FLAT SURFACE ON THE BOTTOM

COMPRESSION & TENSION FORCE

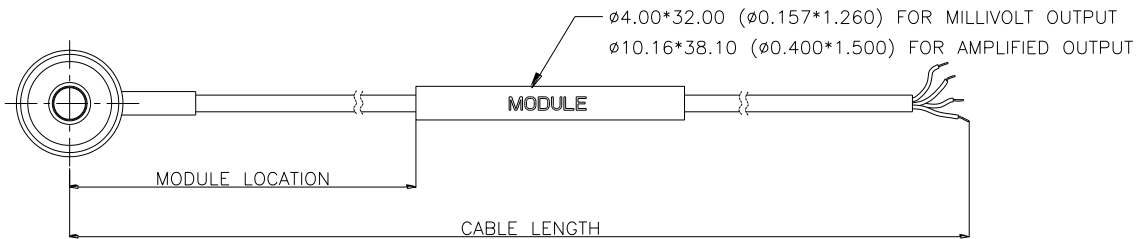
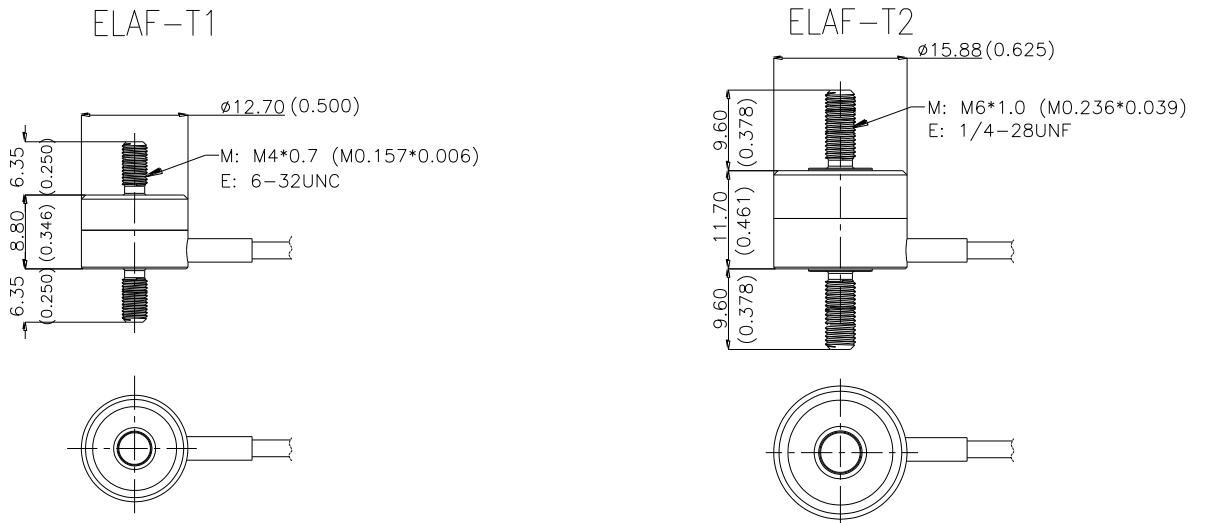

ELAF-T1  
FORCE

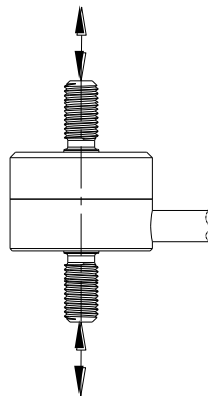

ELAF-T2  
FORCE

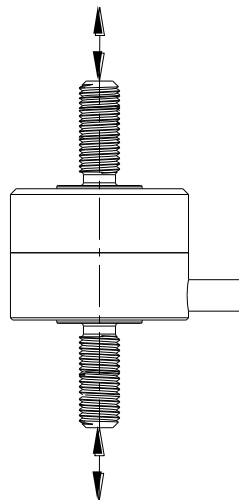

**CONNECTIONS**

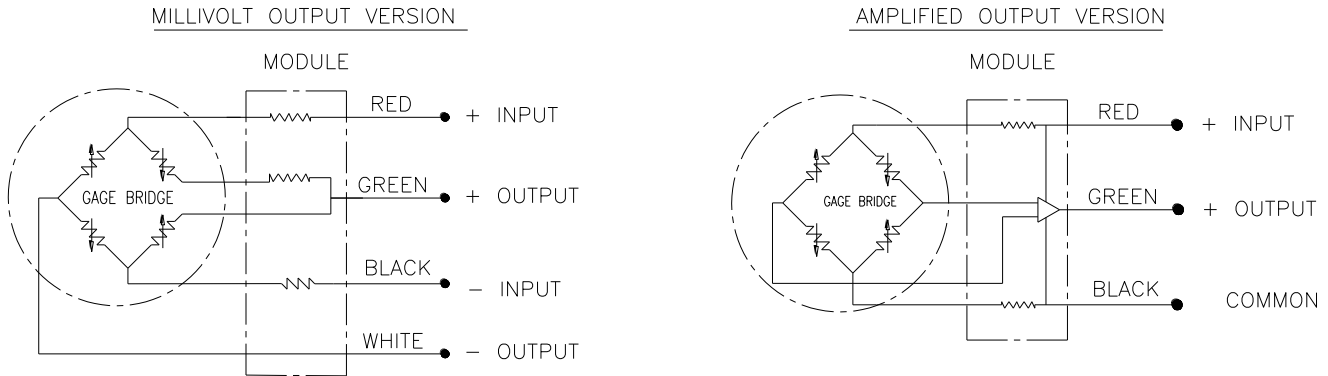

**OPTIONS**

<b>Compensation Temperature Different From 20 to 80°C</b>
Z0: -40 to +20°C
Z1: -20 to +40°C
Z2: 0 to 60°C
Z*: Special compensation temperature range
<b>Excitation Voltage (mV Only): 5 Vdc Standard</b>
V2.5: 2.5V Supply
V10: 10V Supply
Excitation Voltage (Amplified): 5Vdc Standard (Higher excitations available; consult factory)
<b>Cable Length (Standard Cable Length = 1.52m [5ft] )</b>
LxxF: Replace "xx" with total cable length in feet.
LxxM: Replace "xx" with total cable length in meters.
<b>Compensation module Location for B0/B1/T1/T2 Body (Standard module location 305±30mm[12"])</b>
M10P: Module located at 10% of cable length ±5%
M25P: Module located at 25% of cable length ±5%
M50P: Module located at 50% of cable length ±5%
M75P: Module located at 75% of cable length ±5%
MxxP: Special Location
<b>Amplified, AC and P Options</b>
AMP: 0.5 – 4.5V Output. Single force direction
AC: mV Output. Calibration in both tension and compression (stud body only); Zero is 0 ± 5mV. Span is +20mV/V in tension, -20mV/V in compression.
AMP/AC: 0.5 – 4.5V Output. Both tension and compression (stud body only). Zero is 2.5 ± 0.2V
P: (stud body only) mV Output. Calibrated in compression only, positive output in compression.
AMP/P: (stud body only) 0.5 – 4.5V Output. Calibrated in compression only, positive output in compression.
<b>Cable Type</b>
C: Microtech type male or equivalent (w/o mate)
R: RJ12 Telephone type male (w/o mate)

**Notes**

1. For bodies B0, B1, and B2, compression force produces a positive signal.
2. For bodies T1 and T2, tension force produces a positive signal, and default calibration (without option AC) is in tension mode.
3. For amplified output, 5Vdc supply. AMP module is external on cable except on body B2. (Consult factory for higher supply voltage.)

**ORDERING INFORMATION**

**ELAF - T1 - M - 100L - /V10/M25P/...**

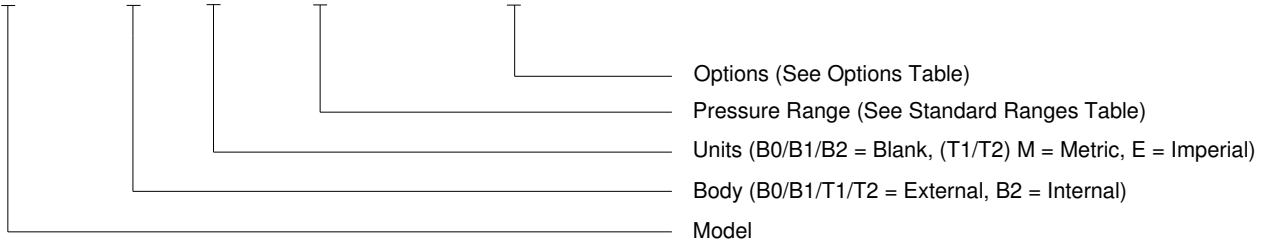

**NORTH AMERICA**

Measurement Specialties, Inc.,  
a TE Connectivity Company  
45738 Northport Loop West  
Fremont, CA 94538  
Tel: 1-800-767-1888  
Fax: 1-510-498-1578  
Sales: pfg.cs.amer@meas-spec.com

**EUROPE**

Measurement Specialties (Europe), Ltd.  
a TE Connectivity Company  
26 Rue des Dames  
78340 Les Clayes-sous-Bois, France  
Tel: +33 (0) 130 79 33 00  
Fax: +33 (0) 134 81 03 59  
Sales: pfg.cs.emea@meas-spec.com

**ASIA**

Measurement Specialties (China), Ltd.,  
a TE Connectivity Company  
No. 26 Langshan Road  
Shenzhen High-Tech Park (North)  
Nanshan District, Shenzhen 518057  
China  
Tel: +86 755 3330 5088  
Fax: +86 755 3330 5099  
Sales: pfg.cs.asia@meas-spec.com

**TE.com/sensorsolutions**

Measurement Specialties, Inc., a TE Connectivity company.

Measurement Specialties, TE Connectivity, TE Connectivity (logo) and EVERY CONNECTION COUNTS are trademarks. All other logos, products and/or company names referred to herein might be trademarks of their respective owners.

The information given herein, including drawings, illustrations and schematics which are intended for illustration purposes only, is believed to be reliable. However, TE Connectivity makes no warranties as to its accuracy or completeness and disclaims any liability in connection with its use. TE Connectivity's obligations shall only be as set forth in TE Connectivity's Standard Terms and Conditions of Sale for this product and in no case will TE Connectivity be liable for any incidental, indirect or consequential damages arising out of the sale, resale, use or misuse of the product. Users of TE Connectivity products should make their own evaluation to determine the suitability of each such product for the specific application.

© 2015 TE Connectivity Ltd. family of companies All Rights Reserved.