



More Precision

thermo**IMAGER** TIM // Compact thermal imaging cameras





thermoIMAGER TIM M-1

Compact infrared camera for short wavelengths in non-contact temperature measurements of metal surfaces

- Highly dynamic CMOS detector with optical resolution up to 764 x 480 pixels
- Very large temperature measuring range (without sub-ranges) from 450 °C to 1800 °C
- Frame rates up to 1 kHz for fast processes
- Real time output of the center pixel up to 1 kHz via process interface (PIF)
- License-free analysis software and complete SDK included

Software

- Display of the thermal image in real time with recording function (video, snapshot)
- Complete set up of parameters and remote control of the camera
- Detailed analysis of fast, thermodynamic processes
- Output of analog temperature or alarm values via the process interface
- Digital communication via RS232 or DLL for software integration

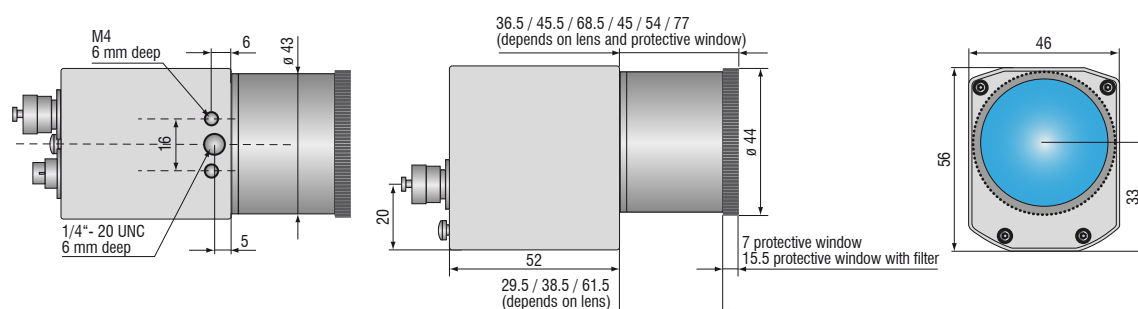
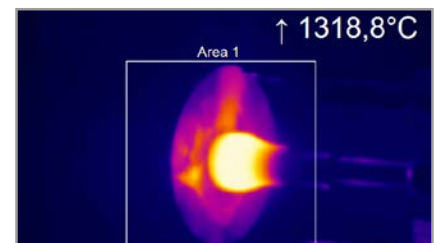
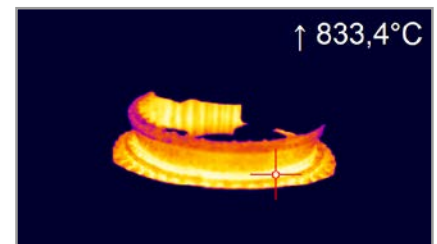
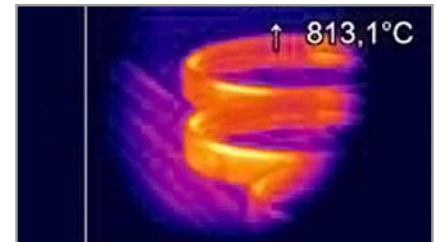

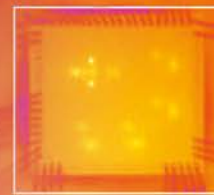

Model	TIM M-1	
Optical resolution	764 x 480 pixels @ 32 Hz 382 x 288 pixels @ 80 Hz (switchable to 27 Hz) 72 x 56 pixels @ 1 kHz ¹⁾ 764 x 8 pixels @ 1 kHz (fast line-scan mode) ¹⁾	
Temperature ranges	450 ⁶⁾ ... 1800 °C (27 Hz mode) 500 ⁶⁾ ... 1800 °C (32 Hz mode) 500 ⁶⁾ ... 1800 °C (80 Hz mode) 600 ⁶⁾ ... 1800 °C (1 kHz mode)	
Spectral range	0.85 to 1.1 μm	
Frame rate	up to 1 kHz / 1 ms real-time analog output (0 - 10 V) from 8 x 8 pixels (freely selectable)	
System accuracy	± 1 % of reading (object temperature < 1400 °C)	
Lenses	FOV @ 764 x 480 px: 39° x 25° (f = 16 mm) ²⁾ 26° x 16° (f = 25 mm) ³⁾ 13° x 8° (f = 50 mm) ⁴⁾ 9° x 5° (f = 75 mm) ⁵⁾	FOV @ 382 x 288 px: 20° x 15° (f = 16 mm) ²⁾ 13° x 10° (f = 25 mm) ³⁾ 7° x 5° (f = 50 mm) ⁴⁾ 4° x 3° (f = 75 mm) ⁵⁾
Thermal sensitivity (NETD)	< 1 K (700 °C) < 2 K (1000 °C)	
Detector	CMOS (15 μm x 15 μm)	
Outputs/digital	USB 2.0 / optional GigE	
Standard process interface (PIF)	0 - 10 V input, digital input (max. 24 V), 0 - 10 V output	
Industry process interface (PIF)	2x 0 - 10 V inputs, digital input (max. 24 V), 3x 0(4) - 20 mA outputs, 3x relays (0 - 30 V / 400 mA), fail-safe relay	
Cable length (USB)	1 m (standard), 5 m, 10 m 5 m and 10 m also available as high temperature USB cable (180 °C or 250 °C)	
Power supply	USB powered	
Tripod mount	¼-20 UNC	
Protection class	IP67 ⁷⁾	
Ambient temperature	5 ... 50 °C	
Storage temperature	-40 ... 70 °C	
Relative humidity	20 to 80 %, non-condensing	
Vibration	IEC 60068-2-6 (sinus-shaped) / IEC 60068-2-64 (broadband noise)	
Shock	IEC 60068-2-27 (25 g and 50 g)	
Housing (size)	46 mm x 56 mm x 88 - 129 mm (depending on lens and focus position)	
Weight	245 - 311 g, incl. lens	

¹⁾ Can be placed anywhere within the FOV

²⁾ Please note: measurement accuracy can be out of specification with distances below 200 mm

³⁾ Please note: measurement accuracy can be out of specification with distances below 500 mm

⁴⁾ Please note: measurement accuracy can be out of specification with distances below 1500 mm

⁵⁾ Please note: measurement accuracy can be out of specification with distances below 2000 mm

⁶⁾ +75 °C higher initial temperature with lenses providing a focal length of f=50 mm and f=75 mm

⁷⁾ Only applies when lens protection tube is used

Scope of supply

TIM M-1

- TIM process camera
incl. a selectable lens
- Lens cap incl. protective window
- Operating instructions
- USB cable 1 m
- Software for real-time processing
and analyzing thermal images
- Tripod mount
- PIF cable incl. terminal block (1 m)
- Transport case
- Optional: Cooling Jacket Advanced,
high temperature cable

thermoIMAGER TIM M-1-N1064

Special model with laser blocking filter at a wavelength of 1064 nm (only 16 mm or 25 mm focal length)

- Measurement during active laser (neodymium-YAG laser)
- High measurement speeds up to 1 kHz

thermoIMAGER TIM M-08

Special narrow-band spectral sensitivity with 800 nm

- Ideal for almost all NIR and CO₂ laser processing applications

Model	TIM M-1-N1064	TIM M-08
Optical resolution	764 x 480 pixels @ 32 Hz 382 x 288 pixels @ 80 Hz (switchable to 27 Hz) 72 x 56 pixels @ 1 kHz ⁵⁾ 764 x 8 pixels @ 1 kHz (fast line-scan mode) ⁵⁾	
Temperature ranges	450 ²⁾ ... 1800 °C (27 Hz mode) 500 ²⁾ ... 1800 °C (32 Hz mode) 500 ²⁾ ... 1800 °C (80 Hz mode) 700 ²⁾ ... 1800 °C (1 kHz mode)	575 °C ... 1900 °C (27 Hz mode) 625 °C ... 1900 °C (32 Hz mode) 625 °C ... 1900 °C (80 Hz mode) 750 °C ... 1900 °C (1 kHz mode)
Spectral range	0.92 - 1.1 μm with blocking filter at 1064 nm / FWHM = 44 nm	780 - 820 nm
Frame rate	up to 1 kHz / 1 ms real-time analog output (0 - 10 V) from 8 x 8 pixels (freely selectable)	
System accuracy	±1 % of reading (object temperature < 1400 °C)	±1 % of reading (object temperature < 1500 °C) ±1.5 % of reading (object temperature > 1500 °C) ³⁾
Lenses	FOV @ 764 x 480 px: 26° x 16° (f = 25 mm) ¹⁾ FOV @ 382 x 288 px: 13° x 10° (f = 25 mm) ¹⁾	
Thermal sensitivity (NETD)	< 1 K (700 °C) < 2 K (1000 °C)	< 2 K (< 1000 °C / 27 Hz to 1 kHz) ⁴⁾
Detector	CMOS (15 μm x 15 μm)	
Outputs/digital	USB 2.0 / optional GigE	
Standard process interface (PIF)	0 - 10 V input, digital input (max. 24 V), 0 - 10 V output	
Industry process interface (PIF)	2x 0 - 10 V inputs, digital input (max. 24 V), 3x 0(4) - 20 mA outputs, 3x relays (0 - 30 V / 400 mA), fail-safe relay	
Cable length (USB)	1 m (standard), 5 m, 10 m 5 m and 10 m also available as high temperature USB cable (180 °C or 250 °C)	
Power supply	USB powered	
Tripod mount	¼-20 UNC	
Protection class	IP67 ⁶⁾	
Ambient temperature	0 ... 50 °C	5 ... 50 °C
Storage temperature	-40 ... 70 °C	
Relative humidity	20 to 80 %, non-condensing	
Vibration	IEC 60068-2-6 (sinus-shaped) / IEC 60068-2-64 (broadband noise)	
Shock	IEC 60068-2-27 (25 g and 50 g)	
Housing (size)	46 mm x 56 mm x 88 - 129 mm (depending on lens and focus position)	
Weight	245 - 311 g, incl. lens	

¹⁾ Please note: measurement accuracy can be out of specification with distances below 500 mm

²⁾ +75 °C higher initial temperature with lenses providing a focal length of f=50 mm and f=75 mm

³⁾ For 1 kHz mode: ±1.5 % of reading (object temperature < 1500 °C) / ±2 % of reading (object temperature > 1500 °C)

⁴⁾ < 4 K (> 1000 °C / 27 Hz to 1 kHz)

⁵⁾ Can be placed anywhere within the FOV

⁶⁾ Only applies when lens protection tube is used

Scope of supply**TIM M-1/M-08**

- TIM process camera incl. a selectable lens
- Lens cap incl. protective window
- Operating instructions
- USB cable 1 m
- Software for real-time processing and analyzing thermal images
- Tripod mount
- PIF cable incl. terminal block (1 m)
- Transport case
- Optional: Cooling Jacket Advanced, high temperature cable



Cooling Jacket Advanced

Universal cooling housing for infrared cameras up to 315 °C

- Ambient operating temperatures up to 315 °C
- Air/Water cooling with integrated air purging and optional protective windows
- Modular design for easy fitting of different devices and lenses
- Easy sensor removal on site due to quick-release chassis
- Integration of additional components such as TIM NetBox, USB Server Gigabit and Industrial Process Interface (PIF) in the extended version

Model	Cooling Jacket Advanced Standard	Cooling Jacket Advanced Extended
Protection class	IP65	IP65
Ambient temperature	up to 315 °C ¹⁾	up to 315 °C ¹⁾
Relative humidity	10 to 95 %, non-condensing	10 to 95 %, non-condensing
Material (housing)	V2A	V2A
Dimensions	271 mm x 166 mm x 182 mm	426 mm x 166 mm x 182 mm
Weight	5.7 kg	7.8 kg
Air purge collar	G1/4" internal thread G3/8" external thread	G1/4" internal thread G3/8" external thread
Cooling water fittings	G1/4" internal thread G3/8" external thread	G1/4" internal thread G3/8" external thread
Cooling water pressure	max. 15 bar (217 psi)	max. 15 bar (217 psi)
Scope of supply	<ul style="list-style-type: none"> ▪ Cooling Jacket Advanced, consisting of housing with mounting angle, chassis ▪ Assembly instructions 	<ul style="list-style-type: none"> ▪ Cooling Jacket Advanced, consisting of housing with mounting angle, chassis ▪ Mounting accessories for TIM NetBox or USB Server Gigabit and Industry PIF ▪ Assembly instructions
	<ul style="list-style-type: none"> ▪ Focusing unit or front attachment ²⁾ 	<ul style="list-style-type: none"> ▪ Focusing unit or front attachment ²⁾

¹⁾ Cable up to 250 °C ambient temperature and cable cooling up to 315 °C available.

²⁾ Must be ordered separately.

Cooling Jacket Advanced – Standard version

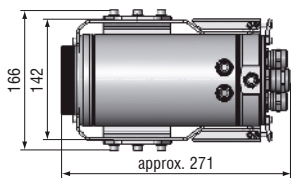

Cooling Jacket Advanced – Extended version

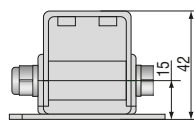
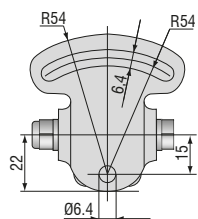
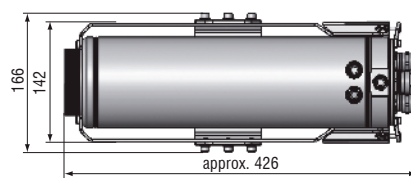

TM-MB-TIM adjustable mounting foot

TM-PH-TIM protection housing incl. mounting foot

TIMConnect SOFTWARE FEATURES

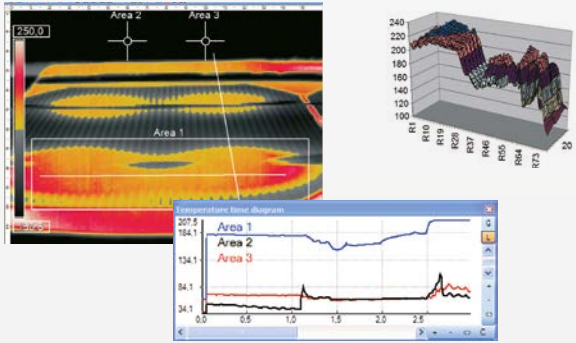

Comprehensive IR camera software

- License-free analysis software and complete SDK included
- Intuitive user interface
- Camera remote control via software
- Displays several camera images in different windows
- Compatible with Windows 7, 8 and 10
- Data output via PIF hardware interface using up to 3 analog channels

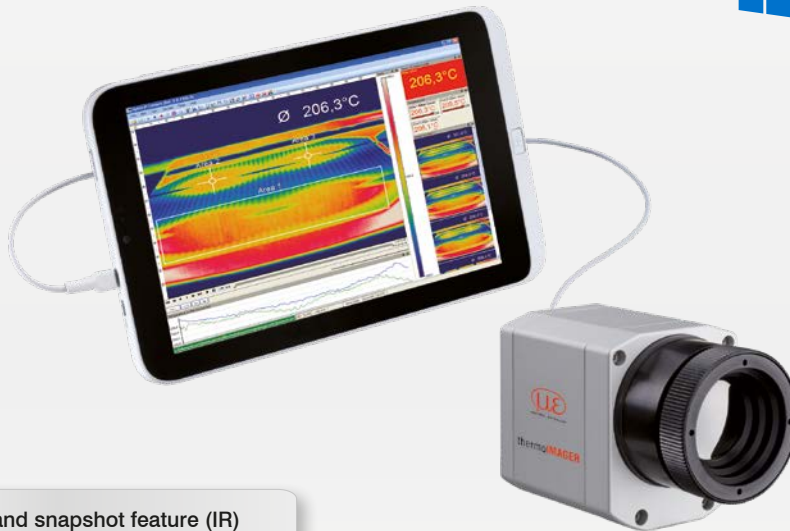

Video recording and snapshot feature (IR)

- Recording of video sequences and individual images for later analysis or documentation
- Adjustable frame rate to reduce data volume
- Display of snapshot process for direct analysis

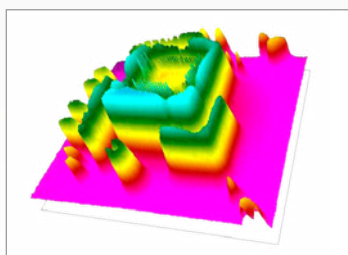
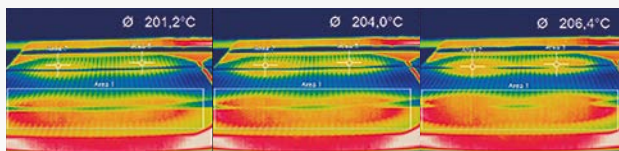

Online and offline data analysis

- Real-time temperature information (°C or °F) in main window, as digital display or graphic display
- Detailed analysis using measuring fields, automatic hotspot/coldspot search
- Logical linking of temperature information
- Slow-motion replay without connected camera
- Various layout functions and color palettes to highlight thermal contrasts

Temperature data analysis and documentation

- Triggered data collection
- Radiometric video sequences (*.ravi) and snapshots (*.tiff)
- Thermal images as *.tiff or *.csv, *.dat text files incl. complete temperature information
- Data transfer in real time to other software programs via DLL or COM port interfaces

Lenses thermoIMAGER TIM M-1 / TIM M-08 / TIM M-05

TIM M-1 / TIM M-08 / TIM M-05 ¹⁾	Focal length [mm]	Angle	Minimum measurement distance*	Distance to measurement object [m]											
					0.1	0.2	0.3	0.5	1	2	4	6	10	30	100
382 x 288 px	16	20° 15° 25° 0.94 mrad	0.2 m	HFOV [m]		0.07	0.11	0.18	0.36	0.72	1.43	2.15	3.6	10.7	35.8
				VFOV [m]		0.05	0.08	0.14	0.27	0.54	1.08	1.62	2.7	8.1	27.0
				DFOV [m]		0.09	0.13	0.22	0.45	0.90	1.79	2.69	4.5	13.5	44.9
				IFOV [mm]		0.2	0.3	0.5	0.9	1.9	3.8	5.6	9.4	28.1	93.8
f=25 mm Standard lens	25	13° 10° 16° 0.60 mrad	0.5 m	HFOV [m]	0.023	0.05	0.07	0.11	0.23	0.46	0.92	1.38	2.3	6.9	22.9
				VFOV [m]	0.017	0.03	0.05	0.09	0.17	0.35	0.69	1.04	1.7	5.2	17.3
				DFOV [m]	0.029	0.06	0.09	0.14	0.29	0.57	1.15	1.72	2.9	8.6	28.7
				IFOV [mm]	0.1	0.1	0.2	0.3	0.6	1.2	2.4	3.6	6.0	18.0	60.0
f=50 mm Telephoto lens	50	7° 5° 8° 0.30 mrad	1.5 m	HFOV [m]				0.06	0.11	0.23	0.46	0.69	1.1	3.4	11.5
				VFOV [m]				0.04	0.09	0.17	0.35	0.52	0.9	2.6	8.6
				DFOV [m]				0.07	0.14	0.29	0.57	0.86	1.4	4.3	14.4
				IFOV [mm]				0.2	0.3	0.6	1.2	1.8	3.0	9.0	30.0
f=75 mm Super telephoto lens	75	4° 3° 5° 0.20 mrad	2.0 m	HFOV [m]					0.08	0.15	0.31	0.46	0.8	2.3	7.6
				VFOV [m]					0.06	0.12	0.23	0.35	0.6	1.7	5.8
				DFOV [m]					0.10	0.19	0.38	0.57	1.0	2.9	9.6
				IFOV [mm]					0.2	0.4	0.8	1.2	2.0	6.0	20.0

¹⁾ TIM M-05 only available with OF25 lens | Please note: the camera provides 382 x 288 px in the 80 Hz mode

* Please note: The measurement accuracy of the camera may lie outside of the specifications for distances below the defined minimum measurement distance.

Lenses thermoIMAGER TIM M-1 / M-08 / M-05 with VGA Resolution

TIM M-1 / M-08 / M-05 ¹⁾ with VGA Resolution 764 x 480 px	Focal length [mm]	Angle	Minimum measurement distance*	Distance to measurement object [m]											
					0.1	0.2	0.3	0.5	1	2	4	6	10	30	100
f=16 mm Wide angle lens	16	39° 25° 46° 0.94 mrad	0.2 m	HFOV [m]		0.14	0.21	0.36	0.72	1.43	2.87	4.30	7.2	21.5	71.6
				VFOV [m]		0.09	0.14	0.23	0.45	0.90	1.80	2.70	4.5	13.5	45.0
				DFOV [m]		0.17	0.25	0.42	0.85	1.69	3.38	5.08	8.5	25.4	84.6
				IFOV [mm]		0.2	0.3	0.5	0.9	1.9	3.8	5.6	9.4	28.1	93.8
f=25 mm Standard lens	25	26° 16° 30° 0.60 mrad	0.5 m	HFOV [m]	0.046	0.09	0.14	0.23	0.46	0.92	1.83	2.75	4.6	13.8	45.8
				VFOV [m]	0.029	0.06	0.09	0.14	0.29	0.58	1.15	1.73	2.9	8.6	28.8
				DFOV [m]	0.054	0.11	0.16	0.27	0.54	1.08	2.17	3.25	5.4	16.2	54.1
				IFOV [mm]	0.1	0.1	0.2	0.3	0.6	1.2	2.4	3.6	6.0	18.0	60.0
f=50 mm Telephoto lens	50	13° 8° 15° 0.30 mrad	1.5 m	HFOV [m]				0.11	0.23	0.46	0.92	1.38	2.3	6.9	22.9
				VFOV [m]				0.07	0.14	0.29	0.58	0.86	1.4	4.3	14.4
				DFOV [m]				0.14	0.27	0.54	1.08	1.62	2.7	8.1	27.1
				IFOV [mm]				0.2	0.3	0.6	1.2	1.8	3.0	9.0	30.0
f=75 mm Super telephoto lens	75	9° 5° 10° 0.20 mrad	2.0 m	HFOV [m]					0.15	0.31	0.61	0.92	1.5	4.6	15.3
				VFOV [m]					0.10	0.19	0.38	0.58	1.0	2.9	9.6
				DFOV [m]					0.18	0.36	0.72	1.08	1.8	5.4	18.0
				IFOV [mm]					0.2	0.4	0.8	1.2	2.0	6.0	20.0

¹⁾ TIM M-05 only available with OF25 lens | Please note: the camera provides 764 x 480 in the 32 Hz mode

* Please note: The measurement accuracy of the camera may lie outside of the specifications for distances below the defined minimum measurement distance.

Sensors and Systems from Micro-Epsilon



Sensors and systems for displacement, distance and position



Sensors and measurement devices for non-contact temperature measurement



Measuring and inspection systems for metal strips, plastics and rubber



Optical micrometers and fiber optics, measuring and test amplifiers



Color recognition sensors, LED analyzers and inline color spectrometers

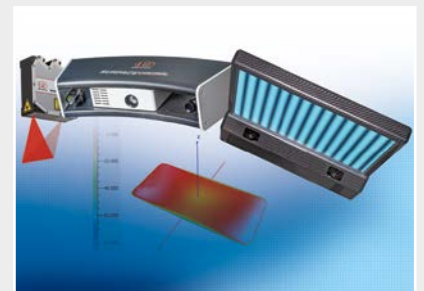

3D measurement technology for dimensional testing and surface inspection