



1630

SPECIFICATIONS

- **Disposable Intra Uterine Pressure Sensor**
- **Disposable Blood Pressure Sensor**
- **AAMI Specifications**
- **Low Cost Disposable**
- **Dielectric Gel Barrier**
- **Fully Tested & Calibrated**

The 1630 is a fully piezoresistive silicon pressure sensor for use in intrauterine pressure monitoring. The sensor is designed to be used with automated assembly equipment and can be dropped directly into a customer's disposable intrauterine housing. The sensor is designed to meet the requirements as described in the Association for the Advancement of Medical Instrumentation (AAMI) specification for Blood Pressure Transducers.

The pressure sensor consists of a pressure sensing element mounted on a ceramic substrate. Thick film resistors on the ceramic substrate are laser trimmed for compensation and calibration. A plastic cap is attached to the ceramic substrate to provide an easy method of attachment to the customer's assembly and protection for the sensing element. A dielectric gel is placed over the sensor to provide fluid isolation.

The 1630 pressure sensors are batch manufactured in a 3x8 element array on a ceramic substrate (24 units per substrate). The products are shipped in anti-static shipping containers. They can also be shipped on a tape and reel. Performance characteristics and packaging can be easily tailored on a special order basis to meet the requirements of specific customers.

FEATURES

- Low Cost, Medical Applications
- Small Size and Reliable Performance
- Gel Isolation for Liquids
- Operates from 10°C to 40°C
- Compatible for Automated Assembly
- 1% Accuracy for Replacements
- 5.0 $\mu\text{V}/\text{V}/\text{mmHg}$ Sensitivity
- Customization for OEM Applications

APPLICATIONS

- Intrauterine Monitoring
- Intensive Care Units
- Infusion Pumps
- Kidney Dialysis Machines
- Vacuum Assisted Birth
- Surgical Procedures

STANDARD RANGES

Range	mmHg
-50 to 300	•

PERFORMANCE SPECIFICATIONS

Supply Voltage: 5.0 Vdc

Ambient Temperature: 23°C (unless otherwise specified)

PARAMETERS	MIN	TYP	MAX	UNITS	NOTES
Operating Pressure Range	-50		300	mmHg	
Over Pressure	-400		1200	mmHg	
Zero Pressure Offset	-20		20	mmHg	
Sensitivity	4.9	5.0	5.1	uV/V/mmHg	
Linearity and Hysteresis (0 to 300 mmHg)	-2.0		2.0	%Span	1
Input Impedance	1200		3200	Ω	
Output Impedance	270		330	Ω	
Supply Voltage	2	5	10	Vdc or Vac rms	
Leakage Current (@ 120 Vac rms, 60Hz)			2	uA	
Warm-Up Time		5		Seconds	
Frequency Response		1200		Hz	
Offset Drift			2	mmHg	2
Thermal Span Shift	-0.1		0.1	%/°C	3
Thermal Offset Shift	-0.3		0.3	mmHg/°C	3
Phase Shift (@ 5KHz)			5	Degrees	
Sterilization (ETO)	3			Cycles	4
Operating Temperature	10		40	°C	
Storage Temperature	-25		+70	°C	
Operating Product Life			72	Hours	
Shelf Life	3			Years	
Humidity (External)	10-90% (non-condensing)				
Media Interface	Dielectric Gel				

Notes

1. Best fit straight line.
2. Over an 8 hour time period after a 10 minute warm-up.
3. Over operating temperature range 10-40°C with respect to 23°C.
4. Sterilization performed by customer.

DIMENSIONS

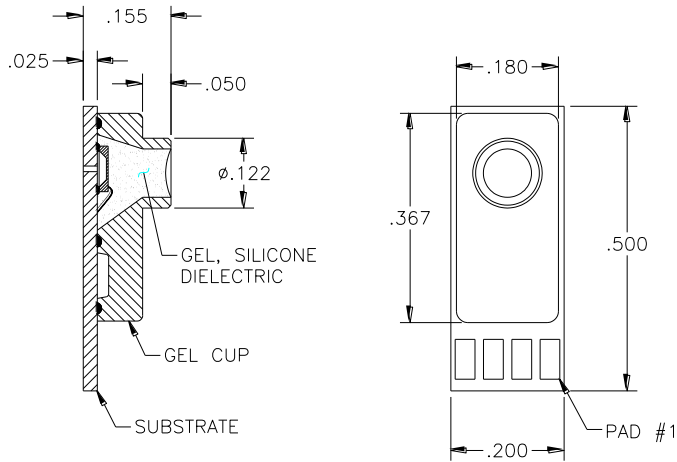

Notes

1. **Materials Used:**
 Substrate: 96% Alumina
 Transducer (Die): Silicon
 Die Attach Adhesive: Room Temperature Vulcanizer
 Lid Adhesive: Medical Grade UV Curing Adhesive
 Conductor And Contact Pads: Platinum-Silver Alloy
 Wire Bonds And Bond Pads: Gold
 Resistors: Ruthenium-Based Thick Film Paste
 Solder Dams: Green Glass
 Protective Gel Lid: Rad-Stable Polycarbonate Resin
2. **Miscellaneous of Gel:**
 Max dimension below surface A = .035" [0.89].
 Max dimension above surface A = .000" [0.000].
3. All dimensions taken at maximum draft.
4. All unspecified fillets and radii are .015" [0.38].
5. All draft angles 1° maximum.

STANDARD PAD CONFIGURATIONS

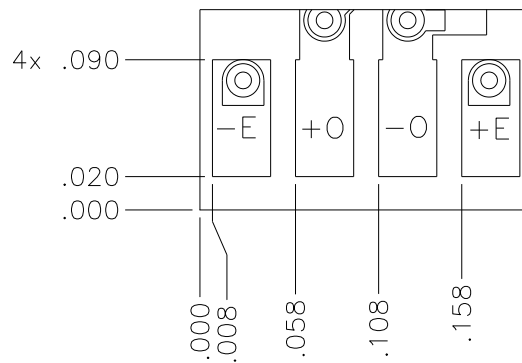

CONNECTIONS

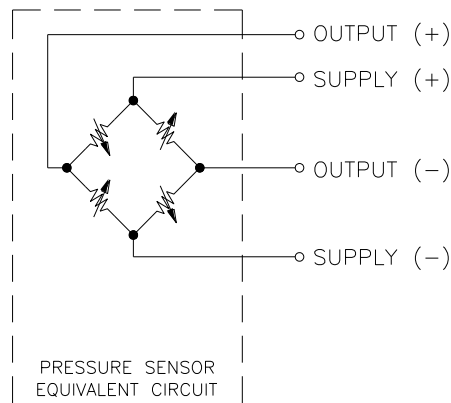

SHIPPING INFORMATION

SHIPPING CONFIGURATION OPTION: TAPE AND REEL

TAPE SPECIFICATIONS
1/2 SCALE

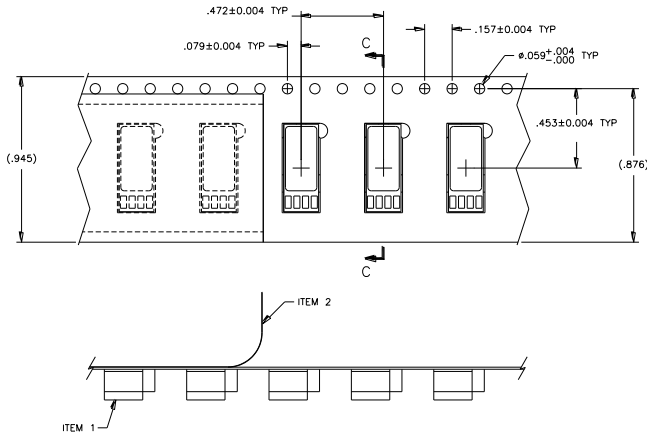

REEL SPECIFICATIONS
1/8 SCALE

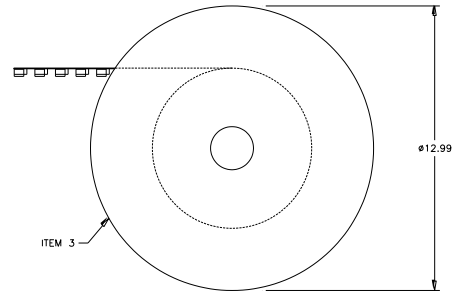

FULL PANEL INFO

- A) SENSORS ARE SHIPPED AS 24 UP SNAPSTRATES AND MUST BE SINGULATED BY THE PURCHASER.
- B) EACH PLATE MAY INCLUDE UNITS THAT HAVE FAILED VISUAL OR ELECTRICAL PARAMETERS AS WELL AS GOOD UNITS. BAD UNITS ARE IDENTIFIED WITH A DOT ON THE BACKSIDE OF THE CELL LOCATION.
- C) PLATES ARE SHIPPED IN DUST FREE ANTI-STATIC CONTAINERS TO PREVENT CONTAMINATION OF THE GEL SURFACE.

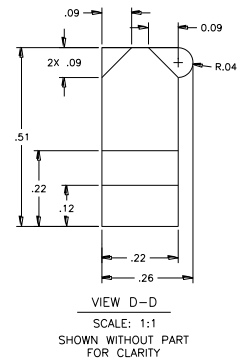
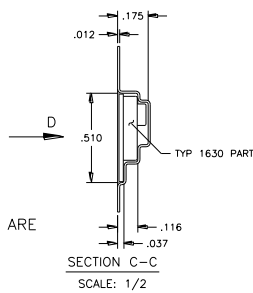

SHIPPING CONFIGURATION OPTION: FULL PANEL

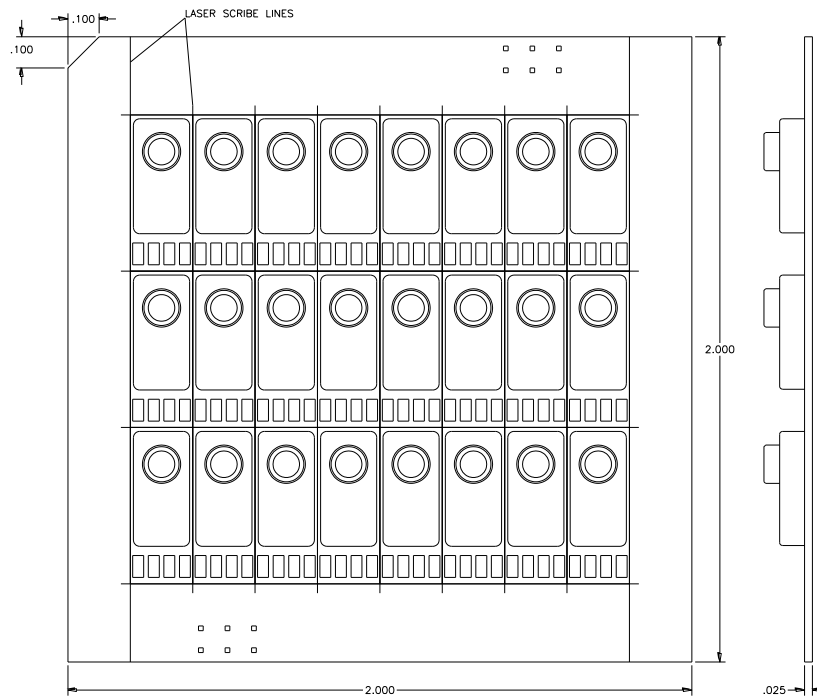

ORDERING INFORMATION

1630 - T

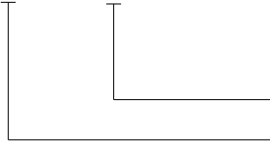

Blank = 24 UP snapstrate, T = Tape and Reel
Model

NORTH AMERICA

Measurement Specialties, Inc.,
a TE Connectivity Company
45738 Northport Loop West
Fremont, CA 94538
Tel: 1-800-767-1888
Fax: 1-510-498-1578
Sales: pfg.cs.amer@meas-spec.com

EUROPE

Measurement Specialties (Europe), Ltd.,
a TE Connectivity Company
26 Rue des Dames
78340 Les Clayes-sous-Bois, France
Tel: +33 (0) 130 79 33 00
Fax: +33 (0) 134 81 03 59
Sales: pfg.cs.emea@meas-spec.com

ASIA

Measurement Specialties (China), Ltd.,
a TE Connectivity Company
No. 26 Langshan Road
Shenzhen High-Tech Park (North)
Nanshan District, Shenzhen 518057
China
Tel: +86 755 3330 5088
Fax: +86 755 3330 5099
Sales: pfg.cs.asia@meas-spec.com

TE.com/sensorsolutions

Measurement Specialties, Inc., a TE Connectivity company.

Measurement Specialties, TE Connectivity, TE Connectivity (logo) and EVERY CONNECTION COUNTS are trademarks. All other logos, products and/or company names referred to herein might be trademarks of their respective owners.

The information given herein, including drawings, illustrations and schematics which are intended for illustration purposes only, is believed to be reliable. However, TE Connectivity makes no warranties as to its accuracy or completeness and disclaims any liability in connection with its use. TE Connectivity's obligations shall only be as set forth in TE Connectivity's Standard Terms and Conditions of Sale for this product and in no case will TE Connectivity be liable for any incidental, indirect or consequential damages arising out of the sale, resale, use or misuse of the product. Users of TE Connectivity products should make their own evaluation to determine the suitability of each such product for the specific application.

© 2015 TE Connectivity Ltd. family of companies All Rights Reserved.