

EE371/EE372 Series

Compact Dew Point Temperature Transmitter / Switch

The exact monitoring of dew point temperature in compressed air systems, dryers for plastic and other industrial processes is becoming increasingly more important. EE371 series with a measuring range $-80...60^{\circ}\text{C Td}$ ($-112...140^{\circ}\text{F Td}$) and

EE372 series with a measuring range $-40...60^{\circ}\text{C Td}$ ($-40...140^{\circ}\text{F Td}$) are the ideal solution for such applications.

The core of the transmitter is the monolithic measurement cell type HMC01, developed by E+E Elektronik in thin-film technology.

An autocalibration procedure which is integrated in the device and years of experience in low humidity adjustment make an accuracy of $<2^{\circ}\text{C Td}$ ($\pm 3.6^{\circ}\text{F Td}$) possible.

The compact construction in a robust aluminium housing and the numerous options allow easy mounting and many application possibilities.



Autocalibration

Dew point temperatures in the range of $-60...-20^{\circ}\text{C}$ ($-76...-4^{\circ}\text{F}$) at room temperature correspond to relative humidity values of 0.08...5.37% RH. The measurement of these low humidity values is not possible with conventional capacitive measurement methods. For the EE371/EE372 series a special autocalibration procedure is utilized to achieve high accuracy measurements at lowest dew points too.

Outputs

Model T: The transmitter has two freely selectable and scaleable outputs for dew point, frost point or ppm volume concentration.

Model S: The switch with two relay outputs is designed for control and alarm purposes. The status for early warning and main alarm is indicated by LED's. Adjustment of the Td/Tf set point and hysteresis can be achieved with the optional configuration software.

Configuration Software

The optional configuration software allows flexible and easy adjustment of the analogue resp. relay outputs to the respective requirements.

The adjustment / calibration of the transmitters can easily be performed.

Screw Connection for Mounting - 360° positionable

The construction of this screw connection enables any position / rotation of the mounted transmitter.

So an optimal position of the display resp. the cable outlet is guaranteed.

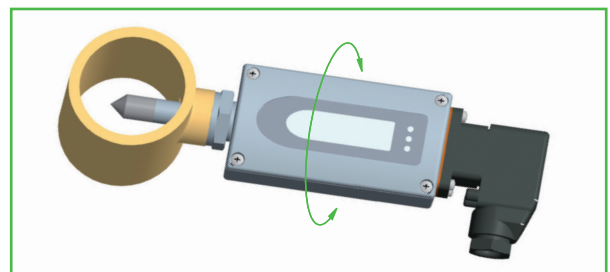

Typical Applications

monitoring of compressed air systems
 refrigerant type dryer
 absorption dryer
 plastics dryer

Features

measuring range $-80...60^{\circ}\text{C Td}$ ($-112...140^{\circ}\text{F Td}$)
 accuracy of measurement $\pm 2^{\circ}\text{C Td}$ ($\pm 3.6^{\circ}\text{F Td}$)
 two Td/Tf alarm outputs
 autocalibration
 pressure tight up to 100 bar (1450psi)

Technical Data

Measuring Quantities

Dew point (Td)

Dew point sensor

Measuring range EE371
EE372

HMC01

-80...60°C Td (-112...140°F Td)
-40...60°C Td (-40...140°F Td)

Traceable to intern. standards, administrated by NIST, PTB, BEV...

Accuracy

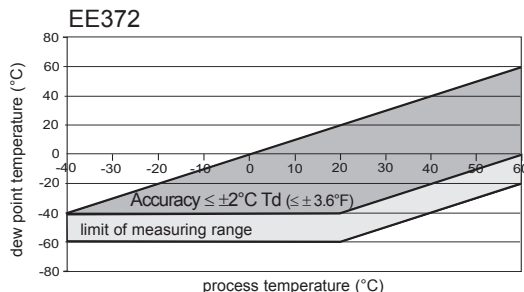
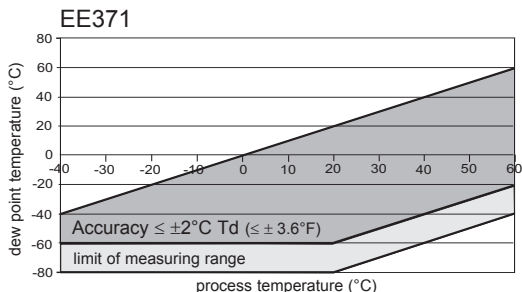

Response time t_{90}

80 sec. -20°C Td → -40°C Td (-4°F Td → -40°F Td)
10 sec. -40°C Td → -20°C Td (-40°F Td → -4°F Td)

Volume concentration

Measuring range EE371
EE372

20...200,000ppm
190...200,000ppm

Accuracy at 20°C (68°F) and 1013mbar

5ppm + 9% of reading

Outputs

EE37x-Tx two freely selectable and scaleable analogue outputs for Td, Tf, Wv

0 - 1V / 0 - 5V / 0 - 10V¹⁾ -1mA < I_L < 1mA
4 - 20mA / 0 - 20mA R_L < 500 Ohm¹⁾

EE37x-Sx Alarm output

2 potential-free relays (NC)
30V DC 0.6A / 35V AC 0.3A (resistive)

General

Supply voltage

10...30V DC

Current consumption at 24V DC

voltage output: typ. 40mA / during autocalibration: 100mA
current output: typ. 80mA / during autocalibration: 140mA

Pressure range

0...20bar (0...290psi) / 0...100bar (0...1450psi)

System requirements for software

WINDOWS 2000 or later; serial interface

Serial interface for configuration

RS232C

Housing / protection class

Al Si 9 Cu 3 / IP65

Electrical connection

7-pole industrial plug: DIN VDE 0627 / IEC 61984
cable cross-section: 0.25 - 1 mm²
cable connection: PG 11

Sensor protection

stainless steel sintered filter

Working temperature range

probe: -40...70°C (-40...158°F)
electronic: -40...60°C (-40...140°F)
with LC display: -20...50°C (-4...122°F)

Storage temperature range

-40...60°C (-40...140°F)

Electromagnetic compatibility according to

EN 61326-1 EN61326-2-3 ICES-003 ClassB
Industrial Environment FCC Part15 ClassB



1) minimum supply voltage 15V DC

Dimensions (mm)

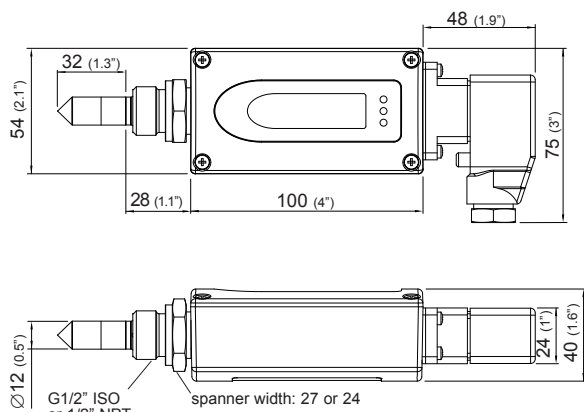

Connection Diagram

analogue output

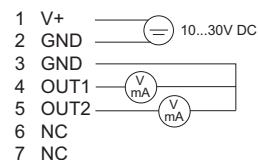

relay output

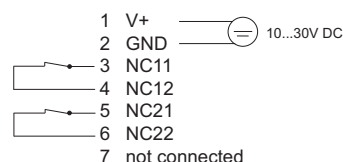

EE371/EE372

Basic Sampling Cell

The basic sampling cell offers the possibility to integrate the EE371/EE372 into an existing or self-constructed sampling system.

- 1 = G 1/2" ISO
- 2 = G 1/4"
- 3 = G 1/4"

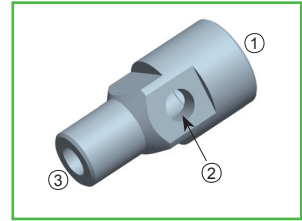

Sampling Cell with Quick Connector up to 10 bar (145psi)

The sampling cell is specially developed for use in compressed air lines and has a quick-connector suitable for standard compressed air connections. It allows for the cell to be fitted and removed without interrupting the process. The flow of gas can be adjusted using a bleed screw.

- 1 = G 1/2" ISO
- 2 = Bleed screw
- 3 = Quick connector

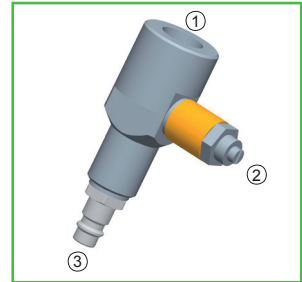

Ordering Guide

Hardware Configuration						
Measuring range	-80...60°C (-112...140°F)				EE371-EE372-	EE371-EE372-
Model	transmitter switch				T	S
Pressure range	up to 20bar (290psi) up to 100bar (1450psi)				E I	E I
Pressure tight feedthrough	G1/2" male thread 1/2" NPT thread				HA03 HA07	HA03 HA07
Display	without display with display				D08	D08
Software Configuration						
Physical parameters of the outputs/relays	dew point temperature	Td	[°C/°F]	(C)	output/relay 1	select according to Ordering Guide (C, D, P)
	frost point temperature	Tf	[°C/°F]	(D)	output/relay 2	
	volume concentration	Wv	[ppm]	(P)		
Type of output signals	0-1V 0-5V 0-10V 0-20mA 4-20mA				1 2 3 5 6	
Measured value units for T / Td / Tf	metric / SI non metric / US				E01	E01
Scaling of Td/Tf-output <small>(in °C or °F)</small>	-40...60 (Td/Tf02)	-80...20 (Td/Tf63)	Other Td/Tf-scaling refer to page 146		select according to Ordering Guide (Tbxx / Tfx)	
ppm range Wv	0...100ppm (X01)	0...500ppm (X02)	0...1000ppm (X03)	other measuring range: _____	select according to Ordering Guide	
Setting of alarm output	standard other set points:	relay 1: _____ hysteresis 1: _____	relay 2: _____ hysteresis 2: _____			SP

Accessories

- sampling cell with quick connector (HA050102)
- basic sampling cell (HA050103)
- configuration software + interface cable (HA010604)
- stainless steel sintered filter (HA010103)
- display (D08)

Order Example

EE372-TEHA07D08/CD2-Td03

Measuring range: -40...60°C
 Model: transmitter
 Pressure range: up to 20bar (290psi)
 Pressure tight feedthrough: 1/2" NPT thread
 Display: with display

Output 1: Td
 Output 2: Tf
 Output signal: 0-5V
 Measured value unit: metric
 Scaling of output: -10...50°C

EE371/EE372